



The Future of Analog IC Technology®

EVmEZDPD3603A-00A

Programmable 36V DC/DC
Power Supply up to 3A

DESCRIPTION

The EVmEZDPD3603A-00A is a programmable, DC/DC, power supply, buck converter featuring the mEZDPD3603A module, which has a multiple-time programmable memory and a simple GUI for programming. The mEZDPD3603A has an input range from 4.5V to 36V. The output voltage is adjustable from 0.6V to 12V (default 3.3V). The EVmEZDPD3603A-00A can output up to 3A of current continuously.

The EVmEZDPD3603A-00A has one mEZDPD3603A socket that should be placed to the EVB manually. The mEZDPD3603A is a programmable, DC/DC, power supply up to 3A and 0.6 - 12V output voltage. The Virtual Bench Pro 2.2 GUI provides flexible power management functions, including setting the output voltage, switching frequency, output current limit, multiple protection modes, and compensation. For more details, please refer to the mEZDPD3603A datasheet.

FEATURES

The mEZDPD3603A comes in a 23mmx16mm solution size. To explore the digital functions of the board completely, the EVmEZDPD3603A-00A board and the Virtual Bench Pro 2.2 GUI are both required. Please contact MPS for more information.

PKT-mEZDPD3603A Kit Contents (Items below can be ordered separately)

#	Part Number	Item	Qty
1	EVmEZDPD3603A-00A	mEZDPD3603A evaluation board	1
2	mEZDPD3603A-0001	mEZDPD3603A modules with default configuration	1
3	EVKT-USBI2C-02	USB to I2C communication interface device kit, includes one USB to I2C communication interface device, USB cable, and ribbon cable	1
4	Tdrive-mEZDPD3603A	USB thumb drive that stores the GUI installation file and supplemental documents	1

Order directly from Monolithicpower.com or our distributors.

EVMEZDPD3603A-00A



DEMO 64mm x 64mm

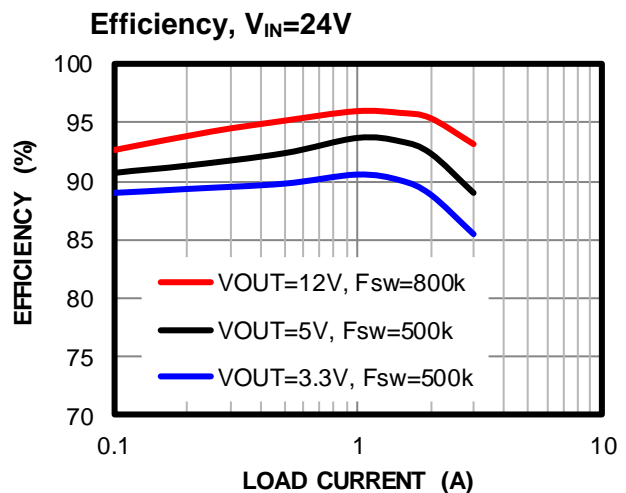

PERFORMANCE SUMMARY

Parameter	Conditions	Value
Input Voltage		4.5V to 36V
Output Voltage	V _{in} =4.5V to 36V, single output, I _{out} =0A to 3A	0.6V to 12V
Output Current	V _{in} =4.5V to 36V, single output, V _{out} =0.6V to 12V	0A to 3A
Typical Efficiency	V _{in} =12V, V _{out} =5V, I _{out} =3A	90%
Peak Efficiency	V _{IN} =24V, V _{OUT} =12V, full load, F _{sw} =800kHz	93.2%
Default Switching Frequency	Typical switching frequency	500kHz

QUICK START

1. Connect the mEZDPD3603A module to the socket on the EVmEZDPD3603A-00A board.
2. Connect the positive and negative terminals of the load to the VOUT and GND pins.
3. Preset the power supply output between 4.5V and 36V.
4. Turn off the power supply.
5. Connect the positive and negative terminals of the power supply to the VIN and GND pins.
6. Turn on the power supply. The board will start up automatically.

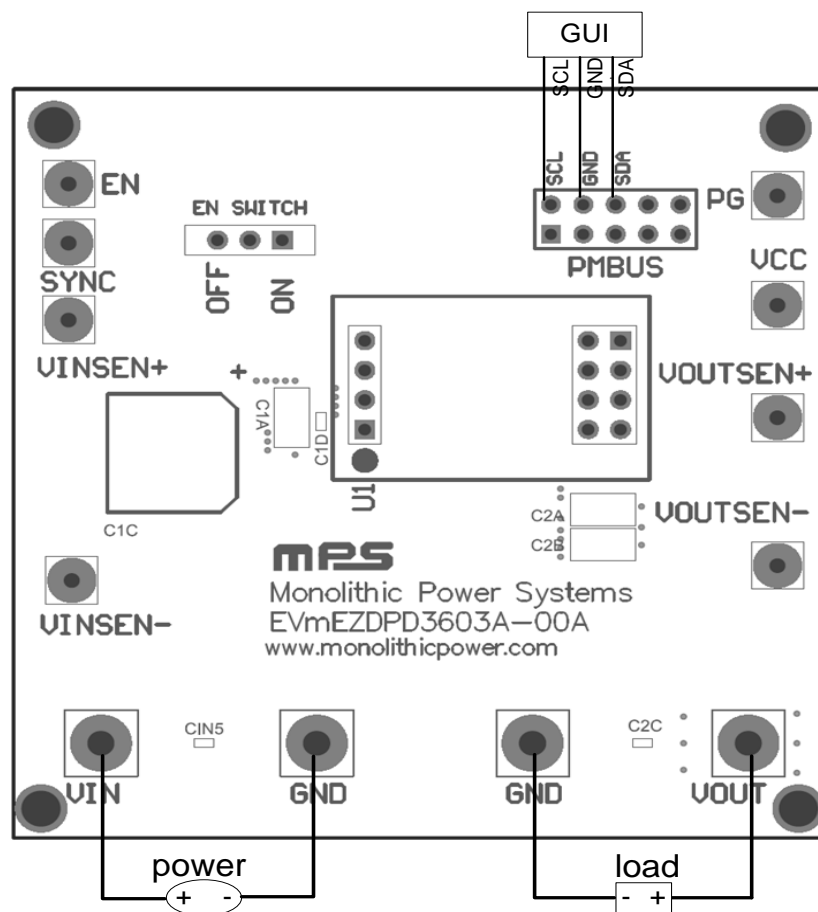

USE VIRTUAL BENCH PRO 2.2 TO EVALUATE DEMO

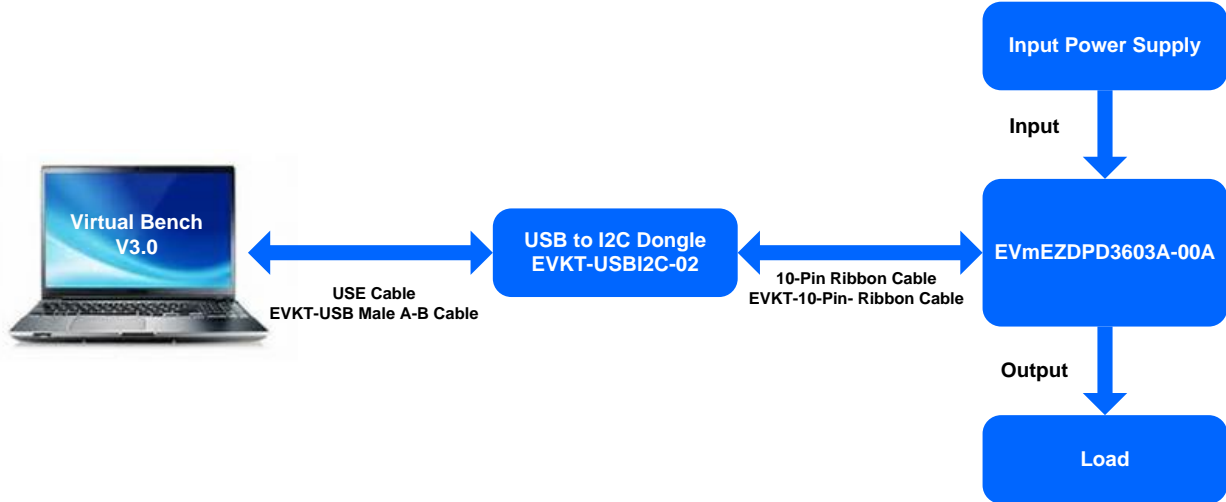

1. Connect the I2C wires to the EVB.
2. Open 'Virtual Bench Pro.exe'. The GUI will auto-scan the device.

When the part is found, the part number will be shown. The GUI allows user modify the internal parameters. For more detail, refer to the register details in IC datasheet.



Evaluation Kit Connection for Programming

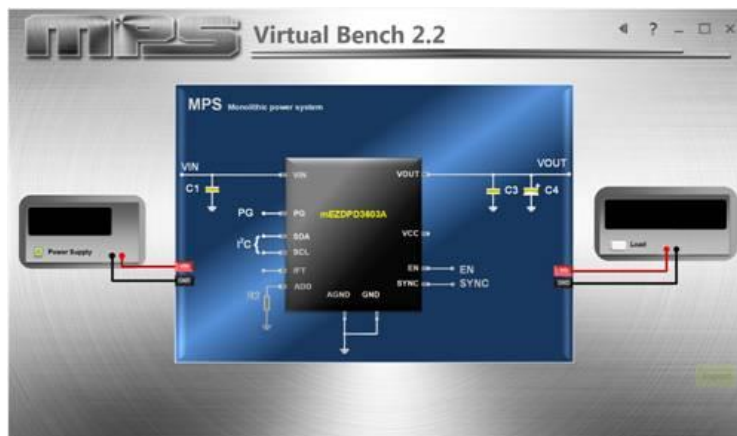

Virtual Ben Pro Main GUI Interface for Programming

TYPICAL PERFORMANCE CHARACTERISTICS

$V_{IN} = 24V$, $V_{OUT} = 5V$, $T_A = 25^\circ C$, unless otherwise noted.

Efficiency

$V_{IN} = 24V$

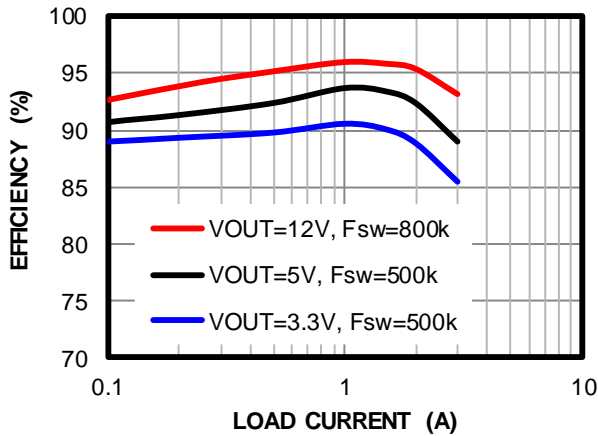

Load Regulation

$V_{IN} = 24V$

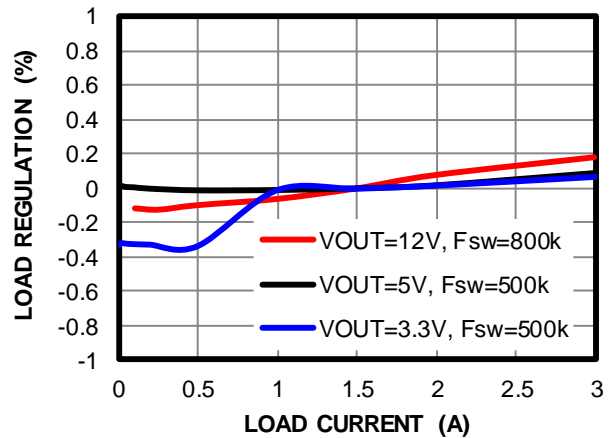

Line Regulation

Full Load

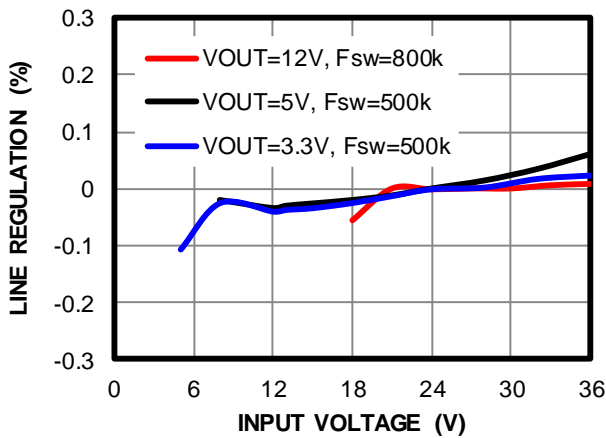

Case Temperature Rise

$V_{IN} = 24V$

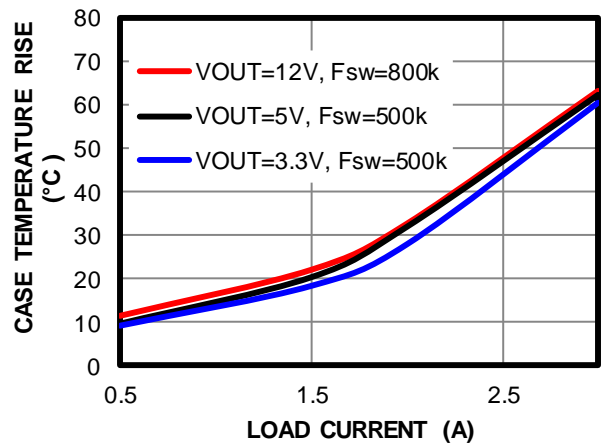

V_{IN} Start-Up

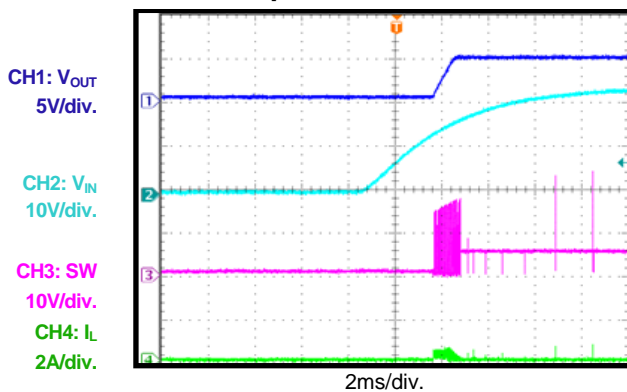

V_{IN} Shutdown

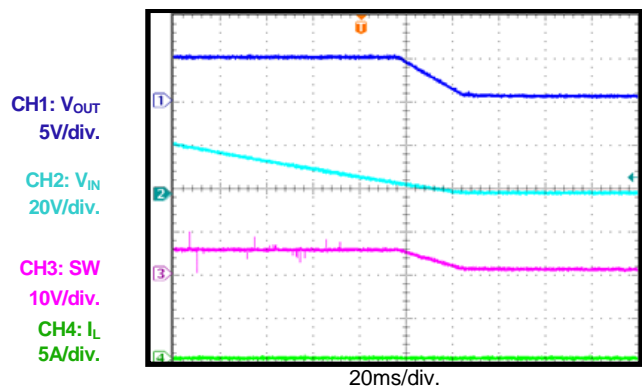

TYPICAL PERFORMANCE CHARACTERISTICS *(continued)*

$V_{IN} = 24V$, $V_{OUT} = 5V$, $T_A = 25^\circ C$, unless otherwise noted.

EN Start-Up

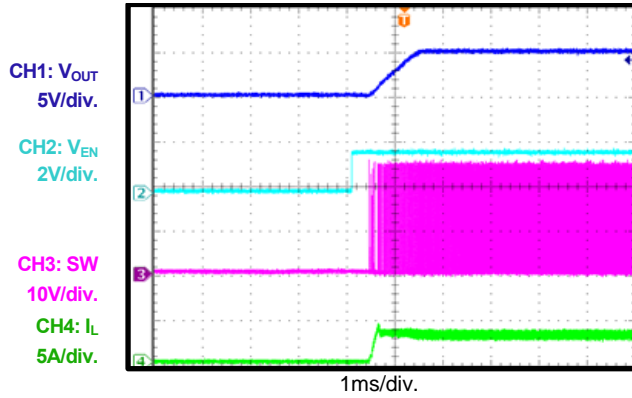

EN Shutdown

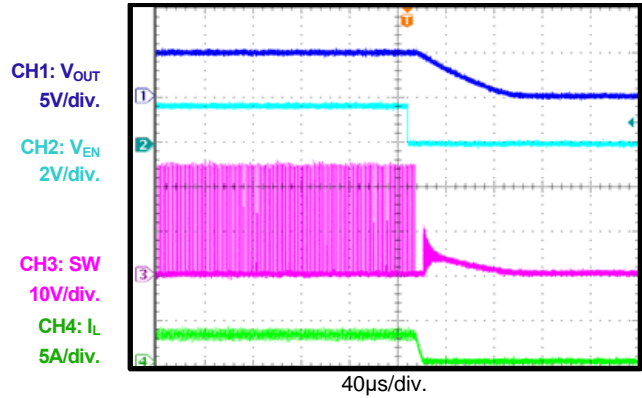

SCP Entry

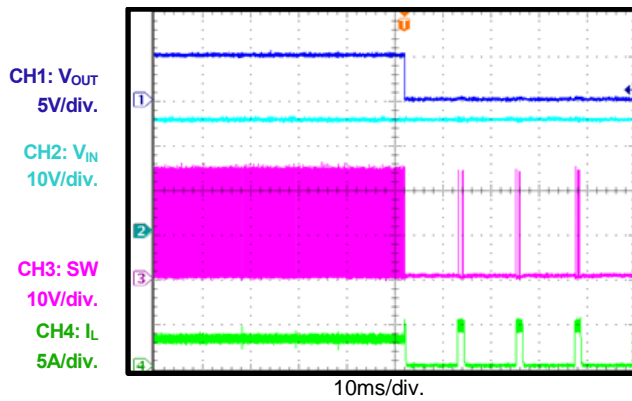

SCP Recovery

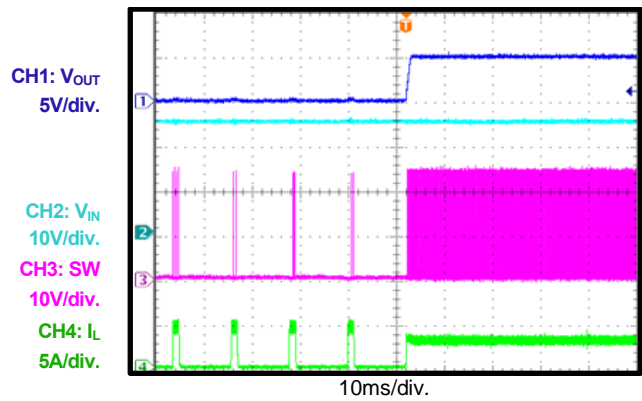

Load Transient

1.5 - 3A, without external C_{OUT}

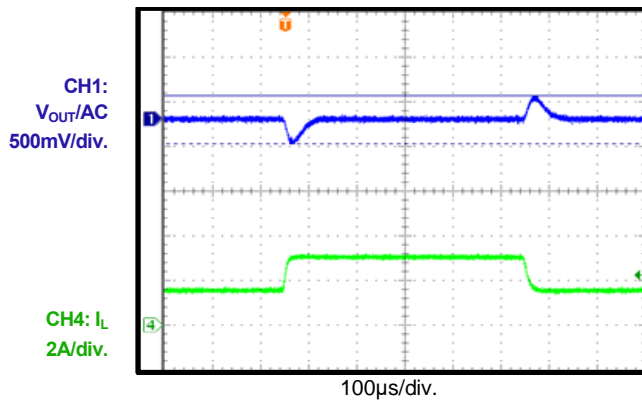

V_{OUT} Ripple

Full Load, without external C_{OUT}

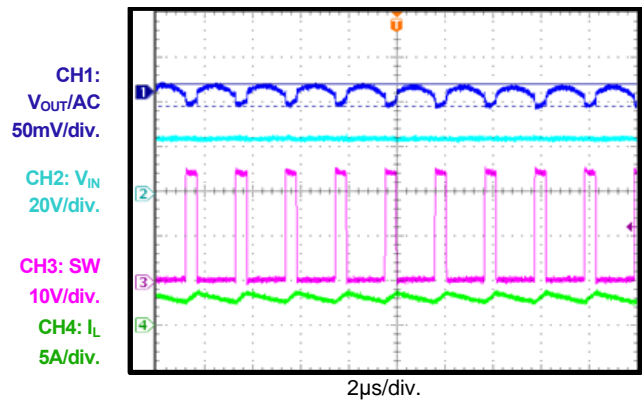

EVMEZDPD3603A-00A SCHEMATIC

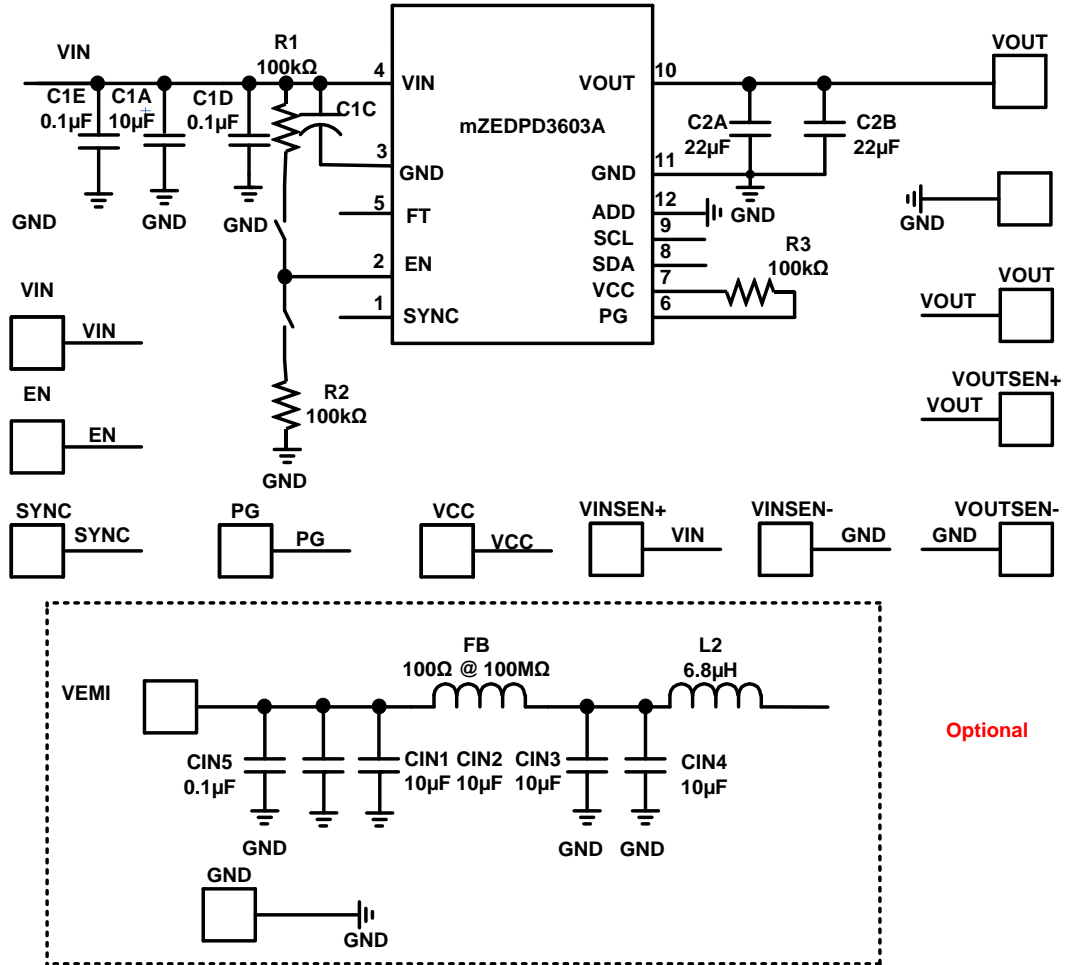

Optional

EVMEZDPD3603A-00A BOM

Qty	RefDes	Value	Description	Pkg	Manufacturer	Manufactuer_P/N
1	C1A	10 μ F	Ceramic Cap.,50V,X5R	1210	Murata	GRM32ER61H106KA12L
2	C2A, C2B	22 μ F	Ceramic Cap.,16V,X5R	1210	Murata	GRM32ER61C226KE20L
2	C2C, C1D	100nF	Ceramic Cap.,50V,X7R	0402	Murata	GRM155R71H104ME14D
3	R1, R2, R3	100k Ω	Film Res,1%,0603, 100k Ω	0603	YAGEO	RC0603FR-07100KL

Optional (EMI)

Qty	RefDes	Value	Description	Pkg	Manufacturer	Manufactuer_P/N
4	CIN1, CIN2, CIN3, CIN4	10 μ F	Ceramic Cap, 50V, X5R	1210	Murata	GRM32ER61H106KA12L
1	CIN5	100nF	Ceramic Cap, 50V, X7R	0402	Murata	GRM155R71H104ME14D
1	FB	100 Ω @ 100MHz 0805	Film Res, 1%, 0805, 100R	0805	YAGEO	RC0805FR-07100RL
1	L2	6.8 μ H	Inductor, RDC=0.09 Ω , Isat=1.25A	4828	WE	744043006

NOTES:

When $V_{OUT} < 3.3V$, C2A = 22 μ F, C2B = NS, C1C = NS
 When $V_{OUT} = 5V$, C2A = 22 μ F, C2B = 22 μ F, C1C = NS
 When $V_{OUT} = 12V$, C2A = 22 μ F, C2B = 22 μ F, C1C = 100 μ F E-cap

PRINTED CIRCUIT BOARD LAYOUT

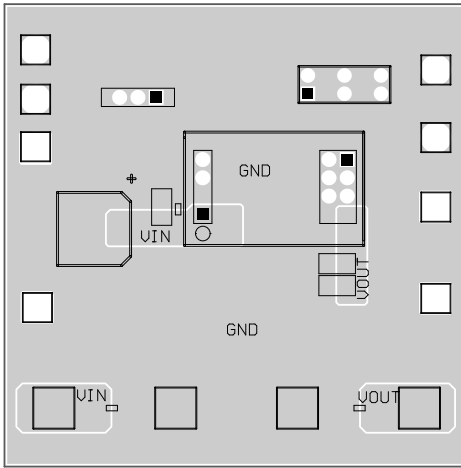

Figure 1: Top Layer

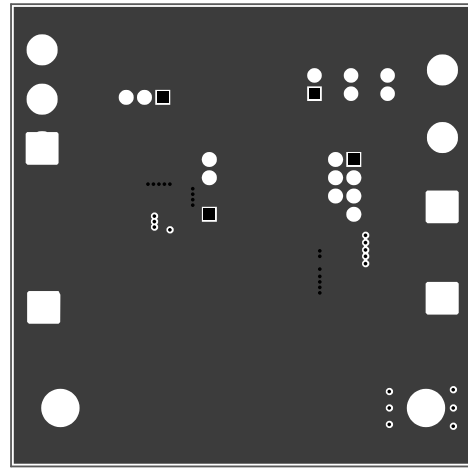

Figure 2: Mid Layer 1

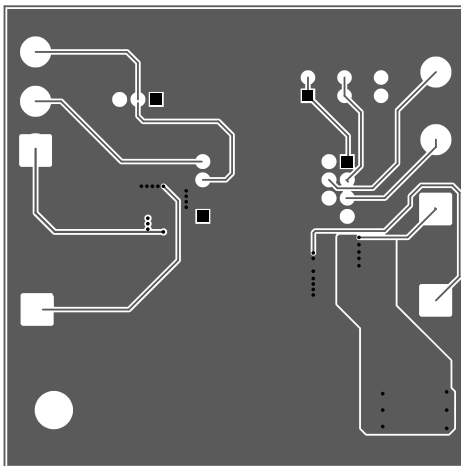

Figure 3: Mid Layer 2

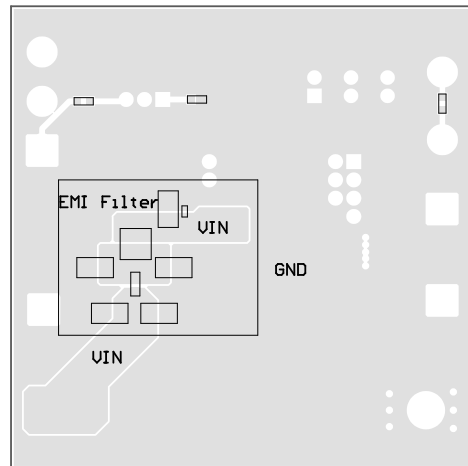

Figure 4: Bottom Layer

NOTICE: The information in this document is subject to change without notice. Users should warrant and guarantee that third party Intellectual Property rights are not infringed upon when integrating MPS products into any application. MPS will not assume any legal responsibility for any said applications.