

Power Module Family

MPS' power modules have a wide range of V_{IN} and I_{OUT} with a variety of packages. Our extensive portfolio of DC/DC modules integrate inductors, FETs, compensation and other passive components into a single package to simplify the design process. Choose what module works best for your design based on our beneficial features. Visit MonolithicPower.com for more information.

Small Size & Ease of Use

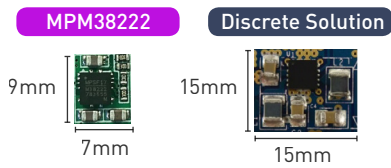

Minimal external components
Easy layout
Fast design cycle

Low EMI

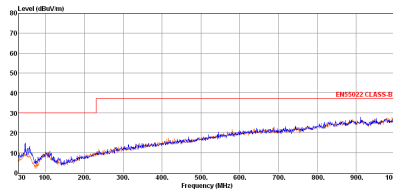

Meet EN55022
Class B EMI standard

Scalability & Programmability

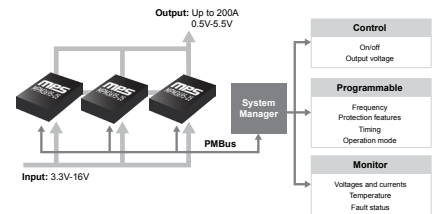

I2C & MTP
Graphic user interface available

MPM3515

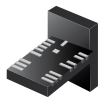

QFN 3x5x1.6mm

- 4V to 36V V_{IN}
- 0.8V to 30.6V V_{OUT}
- Continuous 1.5A Output
- Ext clock synchronization

MPM3570E NEW



LGA 10x10x4.2mm

- 4.5V to 75V V_{IN}
- 1V to 12V V_{OUT}
- Max 0.3A
- Enhanced light-load efficiency
- Ultra-low EMI noise

MPM3683-7 NEW

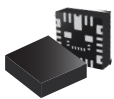

QFN 7x7x4mm

- 2.7V to 16V V_{IN}
- 0.6V to 5.5V V_{OUT}
- Max 8A continuous output
- Fast transient response
- Non-latch OCP, OVP, UVP

MPM3695-25 NEW



LGA 10x12x4mm

- 3V to 16V V_{IN}
- 0.5V to 5.5V V_{OUT}
- Max 25A, parallel up to 200A
- I2C interface & MTP
- GUI available

MPM38222

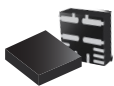

QFN 4x4x1.6mm

- 2.7V to 6V V_{IN}
- Dual output, max 2A
- Enhanced light-load efficiency
- Individual EN pins
- Pin-to-pin with dual 1A MPM38111

MPM3811 NEW



QFN 2x2x1.6mm

- 2.3V to 5.5V V_{IN}
- 0.6V to $D_{max} * 5.5V$
- Max 1A
- Smallest 1A module
- EN, PG pins



Power Module Family

Max V_{IN}	I_{OUT}	0.6A	1.2A	2A	3A	4-5A	6-8A	10A	15A	20A	60A/100A		
Wide V_{IN} 75V		NEW MPM3570E 10x10x4mm			NEW MPM3530 10x12x4mm								
	High Voltage ($\leq 45V$)	MPM3506A 3x5x1.6mm	MPM3510A MPM3515 3x5x1.6mm	NEW MPM3520E 10x10x4mm	SAMPLING mEZD94003A 11x15x4mm SAMPLING mEZD74003L 6x8x1.6mm	NEW MPM3550E 10x10x4mm							
Medium Voltage ($< 24V$)		MPM3606 MPM3606A 3x5x1.6mm	MPM3606 MPM3610A 3x5x1.6mm	MPM3620 MPM3620A 3x5x1.6mm	NEW MPM3632C 3x5x1.6mm	SAMPLING MPM3650 4x6x1.6mm	SAMPLING MPM3695-10 8x8x1.6mm	SAMPLING MPM3695A-10 8x8x1.6mm	MPM3680 12x12x4mm	MPM3682 12x12x4mm	MPM3684 12x15x4mm	MPM3686 12x15x4mm	NEW mEZD81260A 25x15.5x7.5mm
	Low Input ($< 6V$)	MPM3805 3x2.5x0.9mm	MPM3810 3x2.5x0.9mm	MPM3820 3x5x1.6mm	MPM3830 3x5x1.6mm	MPM3840 3x5x1.6mm	MPM3860 4x6x1.6mm						
		MPM3804 2x2x0.9mm	MPM3811 2x2x1.6mm	MPM3822C 2.5x3.5x1.6mm	MPM3833C 2.5x3.5x1.6mm								
			MPM38111 (Dual) 2x2x1.6mm	MPM38222 (Dual) 2.5x3.5x1.6mm									

Power Module Solutions for FPGA

EVREF0103A for Kintex/Zynq Ultrascale+

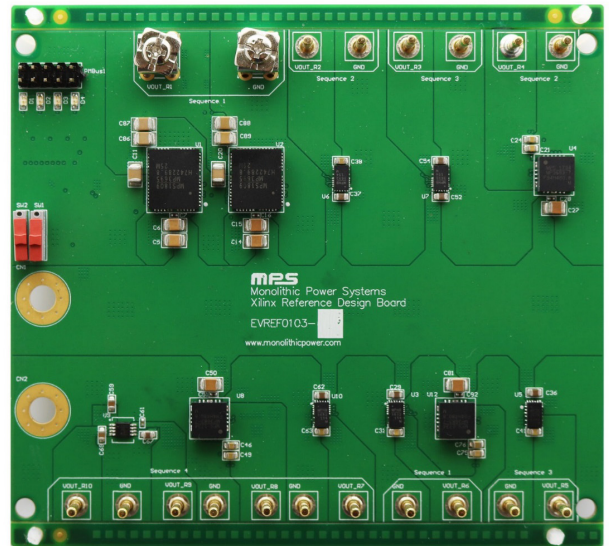
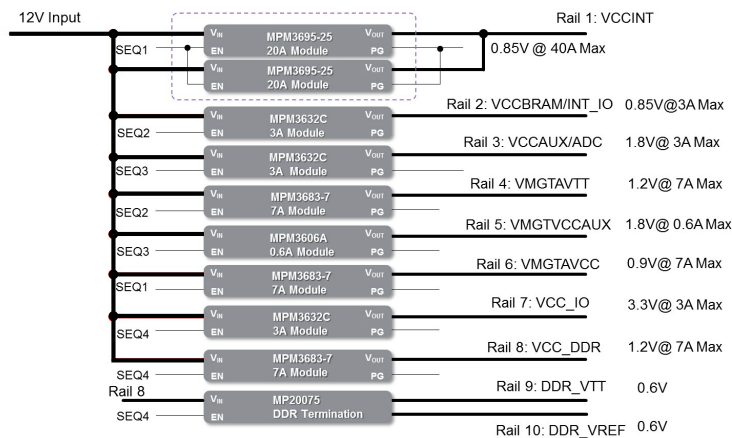

FPGA Series	FPGA Part Numbers	EVB #
VirtexUltrascale/+	VU11P, VU13P	EVREF0104-A
	VU5P, VU7P, VU9P, VU35P, VU37P	EVREF0104-B
	VU3P, VU31P, VU33P	EVREF0104-C
KintexUltrascale/+	KU13P, KU15P	EVREF0103-A
	KU3P, KU5P, KU9P, KU11P	EVREF0103-B
Zynq Ultrascale+ MPSoC	ZU9CG, ZU9EG, ZU11EG-ZU19EG	EVREF0101-A
	ZU3CG to ZU7EV	EVREF0101-B
Zynq 7000	XC7Z007S to XC7Z020, XC7Z030	EVREF0100-A
Zynq Ultrascale+ RFSoc	ZU21DR to ZU29DR	EVREF0102-A

Complete FPGA reference designs available at MonolithicPower.com

