

DESCRIPTION

The EV44010-S+HR1000-S-01B is an evaluation board for a 90W AC-DC adapter. The board is designed in very small size as a name card, so it has high power density. And its electrical specifications are suitable for the typically high-end portable computer power adapter. The particular benefits for the board are the very low no-load power consumption (<0.5W) and the very high global efficiency.

The EV44010-S+HR1000-S-01B is based on two-stage approach: the front stage is a boost PFC pre-regulator using MP44010; the second stage is a half bridge resonant converter with synchronous rectifier using HR1000 and MP6922.

MP44010 is a boundary conduction mode PFC controller which can provide simple and high performance active power factor correction using minimum external components.

HR1000 is a controller designed specifically for the resonant half-bridge ZVS. It controls the output power by changing the switching frequency and controlling the half-bridge with a constant 50% duty cycle. And HR1000 can optimize the light load consumption for the burst mode operation.

ELECTRICAL SPECIFICATIONS

Parameter	Symbol	Value	Units
Input AC Voltage	V_{AC}	90 to 265	V
Output Voltage	V_{OUT}	19.2	V
Output Current	I_{OUT}	4.7	A

FEATURES

- Small Size as A Name Card
- High Power Density
- Active PFC and Maximum Efficiency up to 92.5%
- No Load Power Consumption Less than 0.5W
- Meet EN55022 Class B Standard
- Meet IEC61000-3-2 Class D Standard
- Output Short Circuit Protection
- Over Voltage Protection

APPLICATIONS

- Slim Adapter

All MPS parts are lead-free and adhere to the RoHS directive. For MPS green status, please visit MPS website under Products, Quality Assurance page.

"MPS" and "The Future of Analog IC Technology" are registered trademarks of Monolithic Power Systems, Inc.



High Voltage

Warning: Although this board is designed to satisfy safety requirements, the engineering prototype has not been agency approved. Therefore, all testing should be performed using an isolation transformer to provide the AC input to the prototype

board.

EV44010-S+HR1000-S-01B EVALUATION BOARD

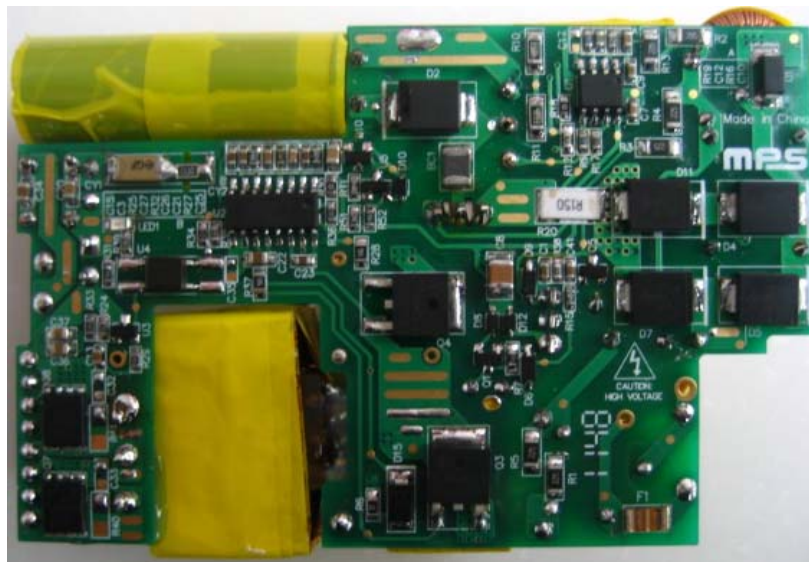
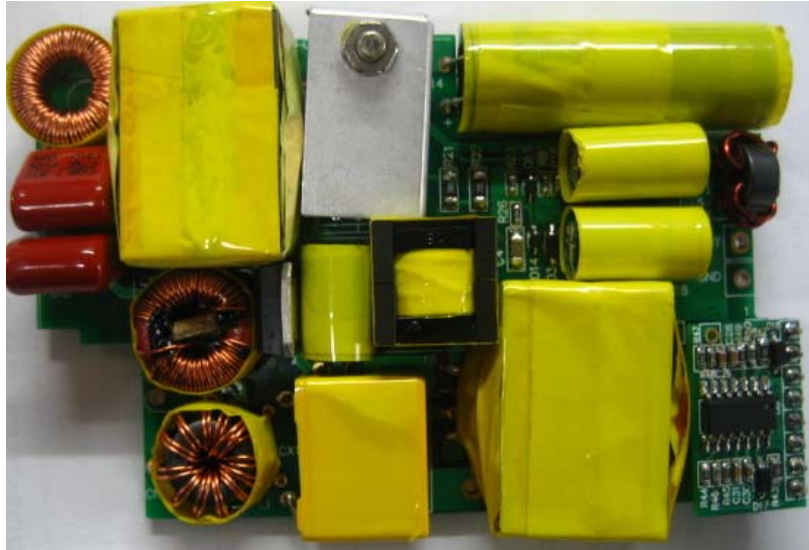

(L x W x H) (88.5cm x 57cm x 14cm)

Board Number	MPS IC Number
EV44010-S+HR1000-S-01B	MP44010
	HR1000
	MP6922

EVALUATION BOARD SCHEMATIC

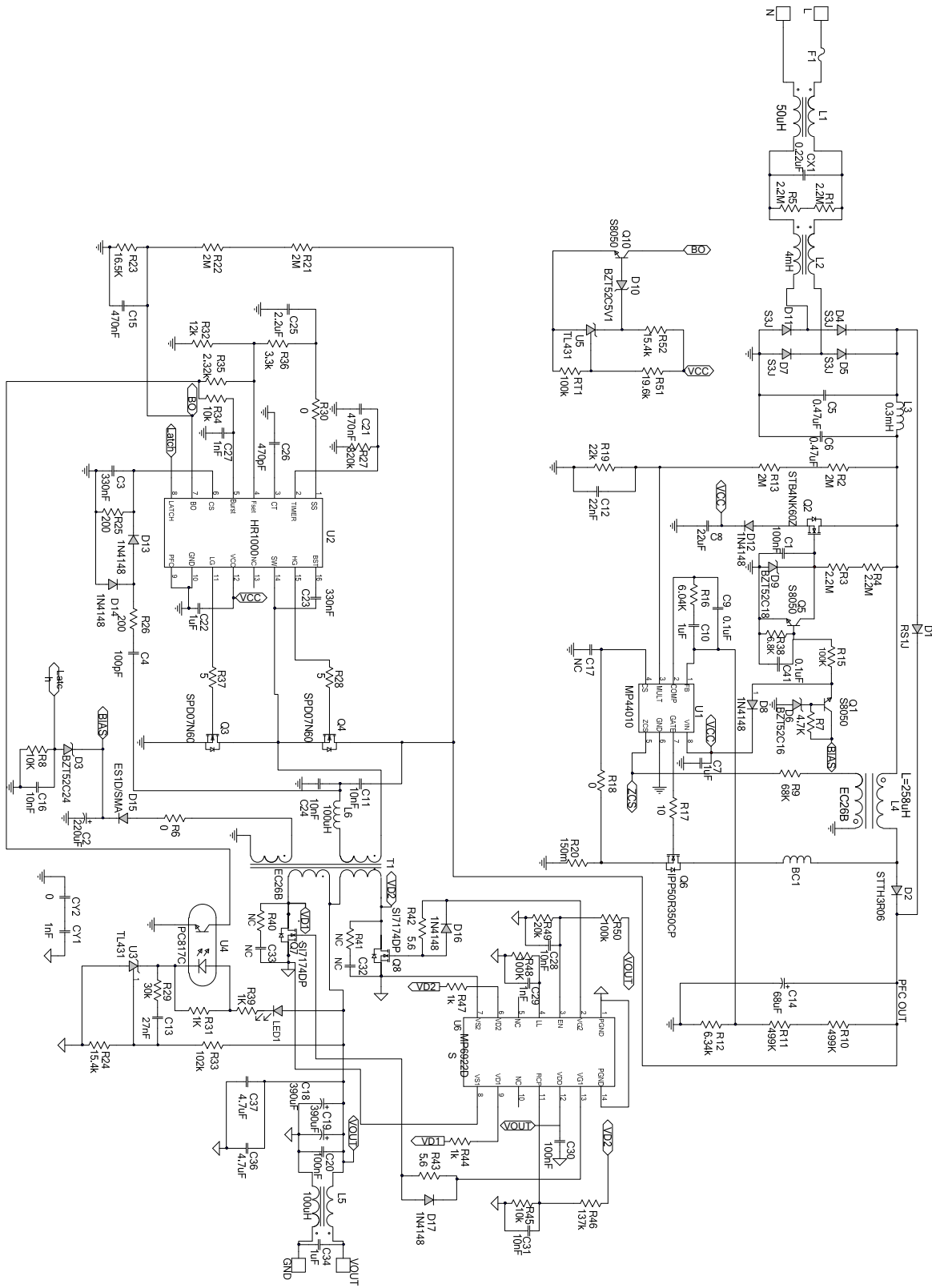

EV44010-S+HR1000-S-01B BILL OF MATERIALS

Qty	Ref	Value	Description	Package	Manufacture	Part Number
1	CX1	0.33µF	Film Cap., X2, 275V	DIP	Carli	PX334K3ID49L270D9R
1	CY1	1nF	Y2 Cap., 2600V	SMD	muRata	GA352QR7GF102KW01L
1	C1	100nF	Ceramic Cap., 25V, X7R	0603	muRata	GRM188R71E104KA01D
1	C2	220µF	Electrolytic Cap., 35V	DIP	Jianghai	CD110-35V220
1	C3	330nF	Ceramic Cap., 16V, X7R	0603	TDK	C1608X7R1C334K
1	C4	100pF	Ceramic Cap., 1000V, X7R	1206	muRata	GRM31A703A101JW31D
2	C5, C6	0.47µF	Film Cap., 450V	DIP	Carli	MTF450 0.47uF
2	C7, C10	1µF	Ceramic Cap., 25V, X7R	0603	muRata	GRM188R71E105KA12
1	C8	22µF	Ceramic Cap., 25V, X7R	1210	muRata	GRM32ER71E226KE
1	C9	100nF	Ceramic Cap., 25V, X7R	0603	TDK	C1608X7R1E104K
2	C11, C24	10nF	Ceramic Cap., 1000V, X7R	1210	muRata	GRM32QR73A103KW01
1	C12	22nF	Ceramic Cap., 50V, X7R	0603	TDK	C1608X7R1H223K
1	C13	27nF	Ceramic Cap., 25V, X7R	0603	HHEC	C0603X273K025T
1	C14	68µF	Electrolytic Cap., 420V	DIP	Rubycon	420QXW 68
2	C15, C21	470nF	Ceramic Cap., 25V, X7R	0603	TDK	C1608X7R1E474K
1	C16	10nF	Ceramic Cap., 50V, X7R	0603	muRata	GRM188R71H103KA01D
2	C18, C19	390µF	Electrolytic Cap., 25V	DIP	Rubycon	25ZLH390
1	C20	100nF	Ceramic Cap., 50V, X7R	0805	Yageo	CC0805KRX7R9BB104
2	C22, C34	1µF	Ceramic Cap., 25V, X7R	0805	muRata	GRM21BR71E105KA99L
1	C23	330nF	Ceramic Cap., 25V, X5R	0603	TDK	C1608X5R1E334K
1	C25	2.2µF	Ceramic Cap., 25V, X7R	0805	muRata	GRM21BR71E225KA73L
1	C26	470pF	Ceramic Cap., 50V, COG	0603	muRata	GRM1885C1H471JA01
2	C27, C29	1nF	Ceramic Cap., 50V, X7R	0603	muRata	C1608X7R1H102K
2	C28, C31	10nF	Ceramic Cap., 50V, X7R	0603	muRata	GRM188R71H103KA01D
2	C30, C41	100nF	Ceramic Cap., 50V, X7R	0603	muRata	GRM188R71H104KA93D
2	C36, C37	4.7µF	Ceramic Cap., 25V, X7R	0805	muRata	GRM21BR71E225KA73L
0	C17, C32, C33, C35 CY2	NC				
1	D1		Diode, 1A , 600V	SMA	Diodes	RS1J
1	D2		Diode, 3A, 600V	SMC	ST	STTH3R06
1	D3		Zener Diode, 5mA, 24V	SOD-123	Diodes	BZT52C24
4	D4, D5 D7, D11		Diode, 3A, 600V	SMC	Vishay	S3J
1	D6		Zener Diode, 5mA, 16V	SOD-123	Diodes	BZT52C16
4	D8, D12 D13, D14		Diode, 0.15A, 75V	SOD-323	Diodes	1N4148WS-7-F
1	D9		Zener Diode, 5mA, 18V	SOD-123	Diodes	BZT52C18
1	D10		Zener Diode, 5mA, 5.1V	SOD-323	Diodes	BZT52C5V1
1	D15		Diode, 1A, 200V	SMA	TAIWAN SEMI	ES1D
2	D16, D17		Diode, 0.15A, 75V	SOD-123	Diodes	1N4148WS

EV44010-S+HR1000-S-01B BILL OF MATERIALS (continued)

Qty	Ref	Value	Description	Package	Manufacture	Part Number
1	F1		250V, 5A	1810	Sleek	SK18T5A
1	BC1		Magnetic Bead	1812	TDK	HF30ACC453215
1	L1	50µH	T10-5-5			
1	L2	4mH			Würth	744821240
1	L3	300µH	TMS127125			
1	L4	258µH	EC26B, 27:9			
1	L5	5.4µH	T8-4-4			
1	L6	100µH	EPC13			
1	T1	850µH	EC26B, 31:3:3:3			
3	Q1, Q5 Q10		Transistor, 0.5A, 25V	SOT-23	Changdian	S8050
1	Q2		MOSFET, 4A, 600V	TO-262	Infineon	STB4NK60Z-1
2	Q3, Q4		MOSFET, 7.3A, 600V	TO-252	Infineon	SPD07N60C3
1	Q6		MOSFET, 10A, 550V	TO-252	Infineon	IPP50R350CP
2	Q7, Q8		MOSFET, 75V	Power PAK SO-8	Vishay	Si7174DP
4	R1, R3 R4, R5	2.2MΩ	Film Res., 5%	1206	Uniohm	1206J0225T5E
4	R2, R13, R21, R22	2MΩ	Film Res., 5%	1206	Uniohm	1206J0205T5E
1	R6	0Ω	Film Res., 5%	0805	Yageo	RC0805JR-070RL
1	R7	4.7kΩ	Film Res., 5%	0603	Uniohm	0603J0472T5E
2	R8, R34	10kΩ	Film Res., 5%	0603	Yageo	RC0603JR-0710K
1	R9	68kΩ	Film Res., 5%	0603	LIZ	CR03T05NJ68K
2	R10, R11	499kΩ	Film Res., 1%	1206	Yageo	RC1206FR-07499KL
1	R12	6.34kΩ	Film Res., 1%	0603	Yageo	RC0603FR-076K34L
2	R15, R50	100kΩ	Film Res., 5%	0603	Yageo	RC0603JR-07100KL
1	R16	6.2kΩ	Film Res., 5%	0603	LIZ	CR0603JA0622G
1	R17	10Ω	Film Res., 5%	0603	Yageo	0603SAJ0100T5E
2	R18, R30	0Ω	Film Res., 5%	0603	Yageo	RC0603JR-070RL
1	R19	22kΩ	Film Res., 5%	0603	LIZ	CR0603JA0223G
1	R20	150mΩ	Film Res., 1%;	2512	CYNTEC	RL-3264-150mFNH
1	R23	15.8kΩ	Film Res., 5%	0603	Yageo	RC0603FR-0715K8L
1	R24	15.4kΩ	Film Res., 1%	0603	Yageo	RC0603FR-0715K4L
2	R25, R26	200Ω	Film Res., 1%	0603	Yageo	RC0603FR-07200RL
1	R27	820kΩ	Film Res., 5%	0603	LIZ	CR0603JA824G
4	R28, R37 R42, R43	5.6Ω	Film Res., 5%	0805	Yageo	RC0805JR-075R6L
1	R29	33kΩ	Film Res., 5%	0603	LIZ	CR0603JA0333G
1	R31	1kΩ	Film Res., 5%	0603	Uniohm	0603J0102T5E

EV44010-S+HR1000-S-01B BILL OF MATERIALS (continued)

Qty	Ref	Value	Description	Package	Manufacture	Part Number
1	R32	12kΩ	Film Res., 5%	0603	SYN- TON- TECH	RC0603FR-0712KL
1	R33	102kΩ	Film Res., 1%	0603	Yageo	RC0603FR-07102KL
1	R35	2.32kΩ	Film Res., 1%	0603	Yageo	RC0603FR-072K32L
1	R36	3.3kΩ	Film Res., 1%	0603	Yageo	RC0603FR-073K3L
1	R38	6.8kΩ	Film Res., 5%	0603	LIZ	RC0603JA0682G
1	R39	1kΩ	Film Res., 5%	0603	Uniohm	0603J0102T5E
2	R44, R47	1kΩ	Film Res., 5%	0805	Uniohm	0805J0102T5E
1	R45	10kΩ	Film Res., 5%	0603	Yageo	RC0603JR-0710K
1	R46	137kΩ	Film Res., 1%	0603	Yageo	RL0603FR-07137KL
1	R48	100kΩ	Film Res., 5%	0603	Yageo	RC0603FR-07100KL
1	R49	20kΩ	Film Res., 1%	0603	Yageo	RC0603FR-072KL
1	R51	19.6kΩ	Film Res., 5%	0603	Yageo	RC0603FR-0719K6
1	R52	15kΩ	Film Res., 5%	0603	Yageo	RC0603JR-0715KL
0	R40, R41	NC		0		
1	RT1	100kΩ	Film Res., 5%	0603	muRata	NCP18WF104F12RB
1	U1		PFC Controller	SO-8	MPS	MP44010HS
1	U2		LLC Resonant Controller	SO-16	MPS	HR1000HS
2	U3, U5		2.5V	SOT-23	Changdian	CJ431
1	U4		Photocoupler	SMD	Sharp	PC357NT
1	U6		SR Controller	SO-14	MPS	MP6922DS
1	LED1		Green	0805	BRIGHT LED	BL-HGE35A-TRB

EVB TEST RESULTS

Performance waveforms are tested on the evaluation board.

$V_{AC}=90V-265V$, $V_{OUT}=19.2V$, $I_{OUT}=4.7A$

Efficiency vs. V_{AC}

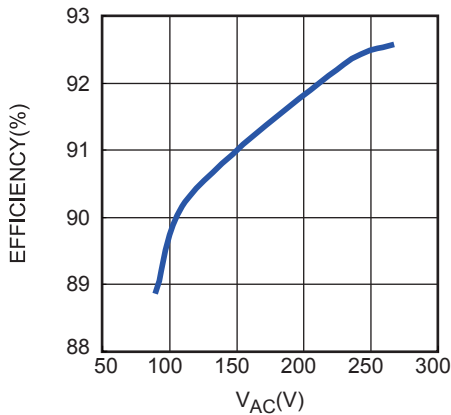

PF & THD vs. V_{AC}

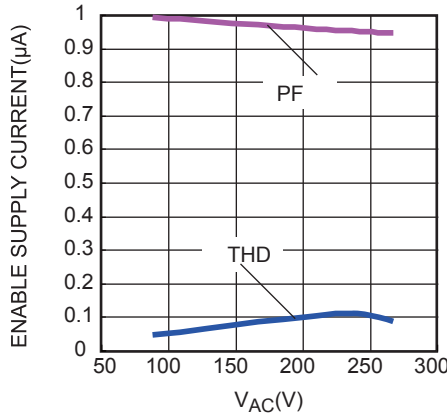

Harmonics

$V_{AC}=115V/230V$

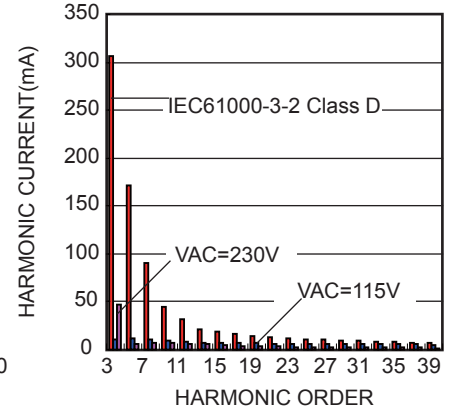

Conducted EMI

$V_{AC}=230V$

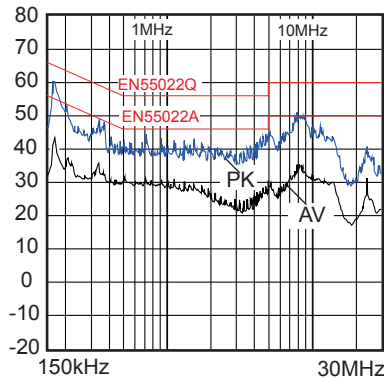

EVB TEST RESULTS *(continued)*

Performance waveforms are tested on the evaluation board.

$V_{AC}=90V-265V$, $V_{OUT}=19.2V$

Steady State

$V_{AC}=115V$, $I_{OUT}=4.7A$

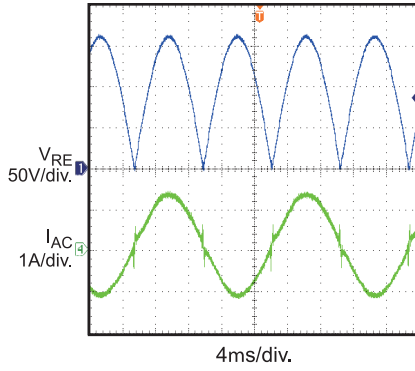

Steady State

$V_{AC}=230V$, $I_{OUT}=4.7A$

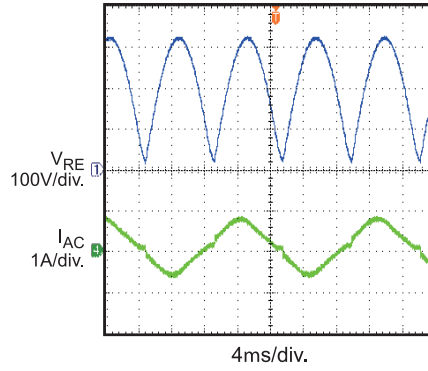

Steady State

$V_{AC}=115V$, $I_{OUT}=4.7A$

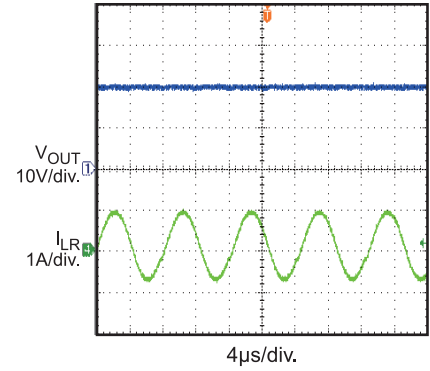

Steady State

$V_{AC}=115V$, $I_{OUT}=0A$

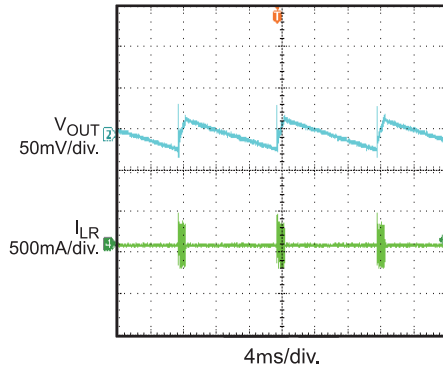

Steady State

$V_{AC}=230V$, $I_{OUT}=0A$

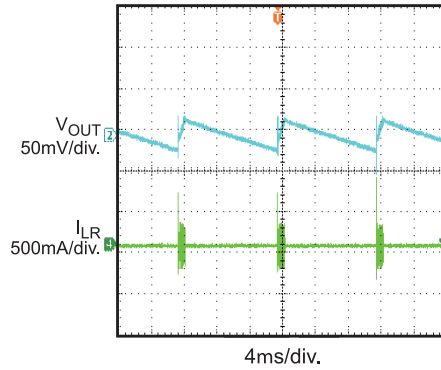

Start Up

$V_{AC}=115V$, $I_{OUT}=4.7A$

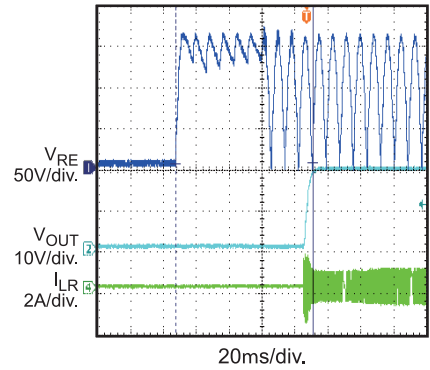

Start Up

$V_{AC}=230V$, $I_{OUT}=4.7A$

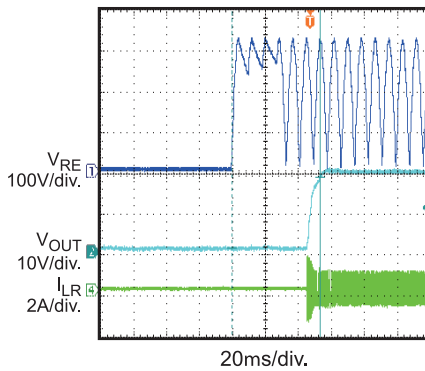

Transient

$V_{AC}=115V$, $I_{OUT}=4.7A$ to 2.35A

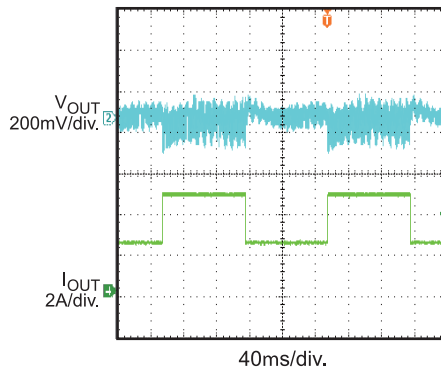

Transient

$V_{AC}=230V$, $I_{OUT}=4.7A$ to 2.35A

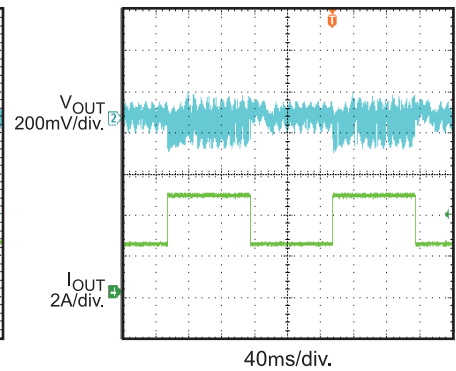

EVB TEST RESULTS *(continued)*

Performance waveforms are tested on the evaluation board.

$V_{AC}=90V-265V$, $V_{OUT}=19.2V$

Short Entry

$V_{AC}=115V$, $I_{OUT}=4.7A$

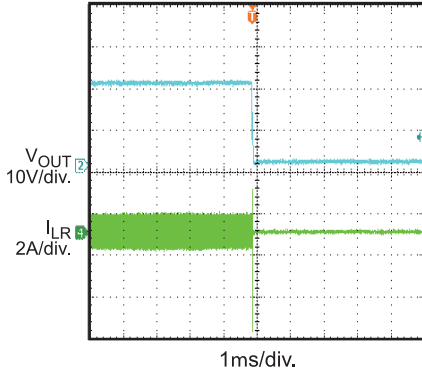

Short Steady State

$V_{AC}=115V$, $I_{OUT}=4.7A$

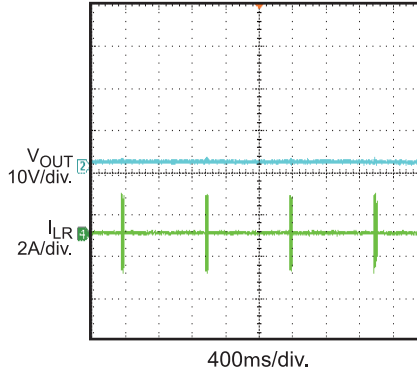

Short Recovery

$V_{AC}=115V$, $I_{OUT}=4.7A$

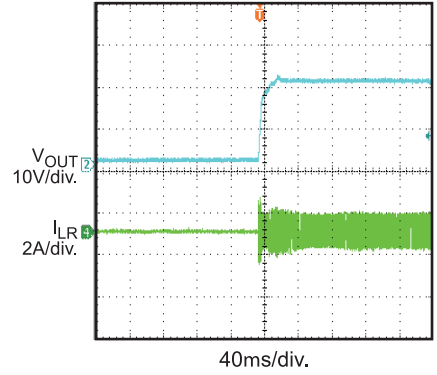

OVP Entry

$V_{AC}=115V$, $I_{OUT}=4.7A$

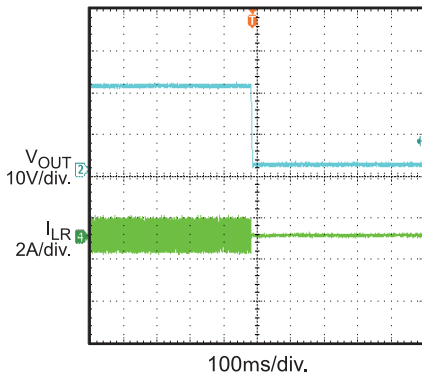

OVP Steady State

$V_{AC}=115V$, $I_{OUT}=4.7A$

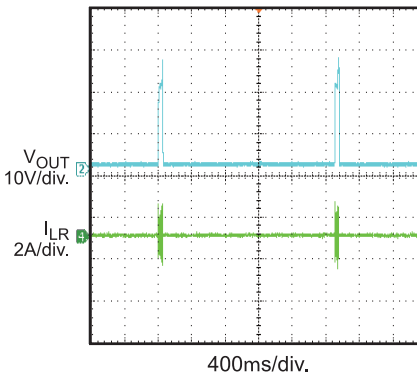

OVP Recovery

$V_{AC}=115V$, $I_{OUT}=4.7A$

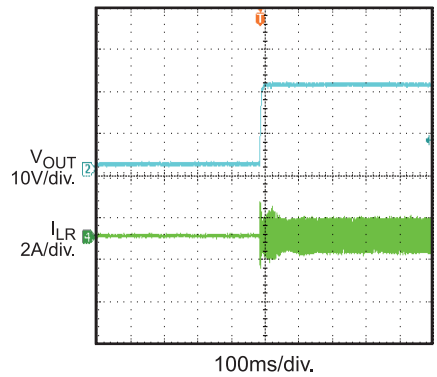

PRINTED CIRCUIT BOARD LAYOUT

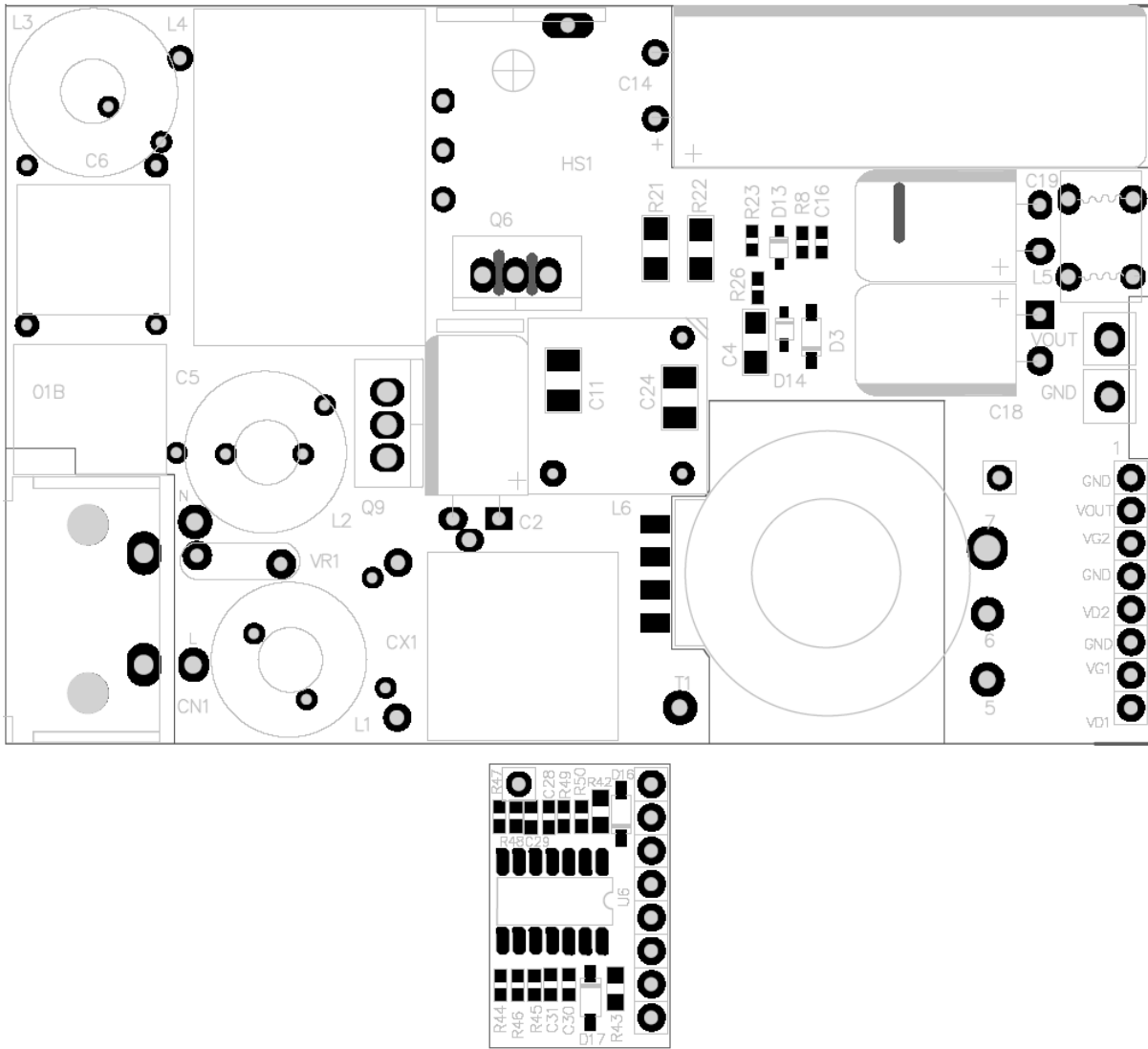

Figure 1—Top Silk Layer

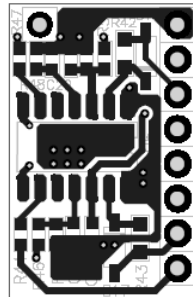
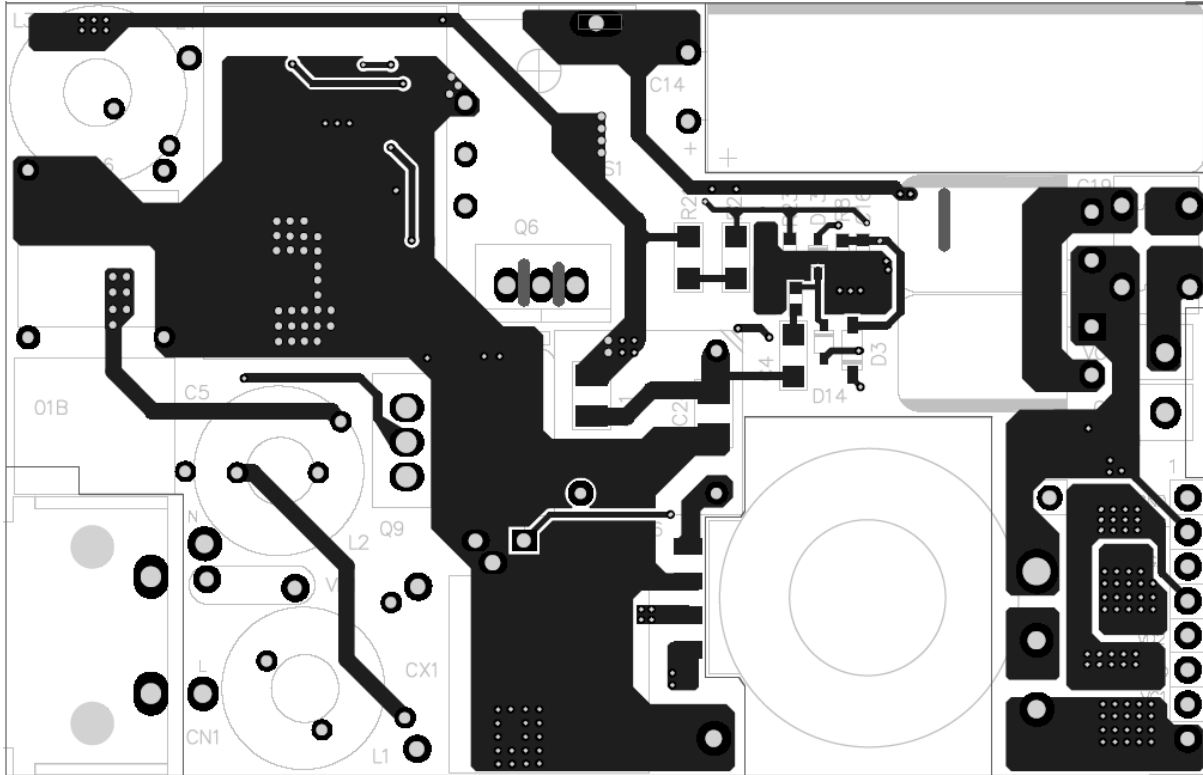

Figure 2—Top Layer

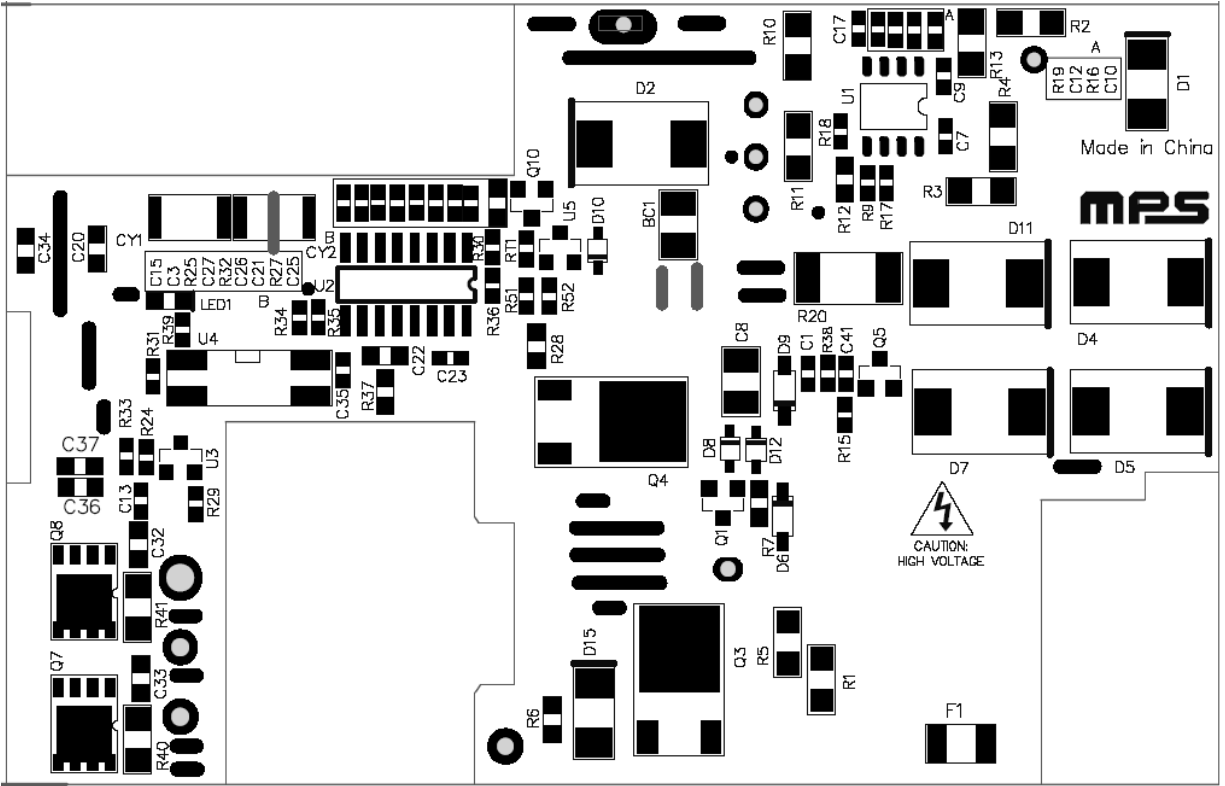

Figure 3—Bottom Silk Layer

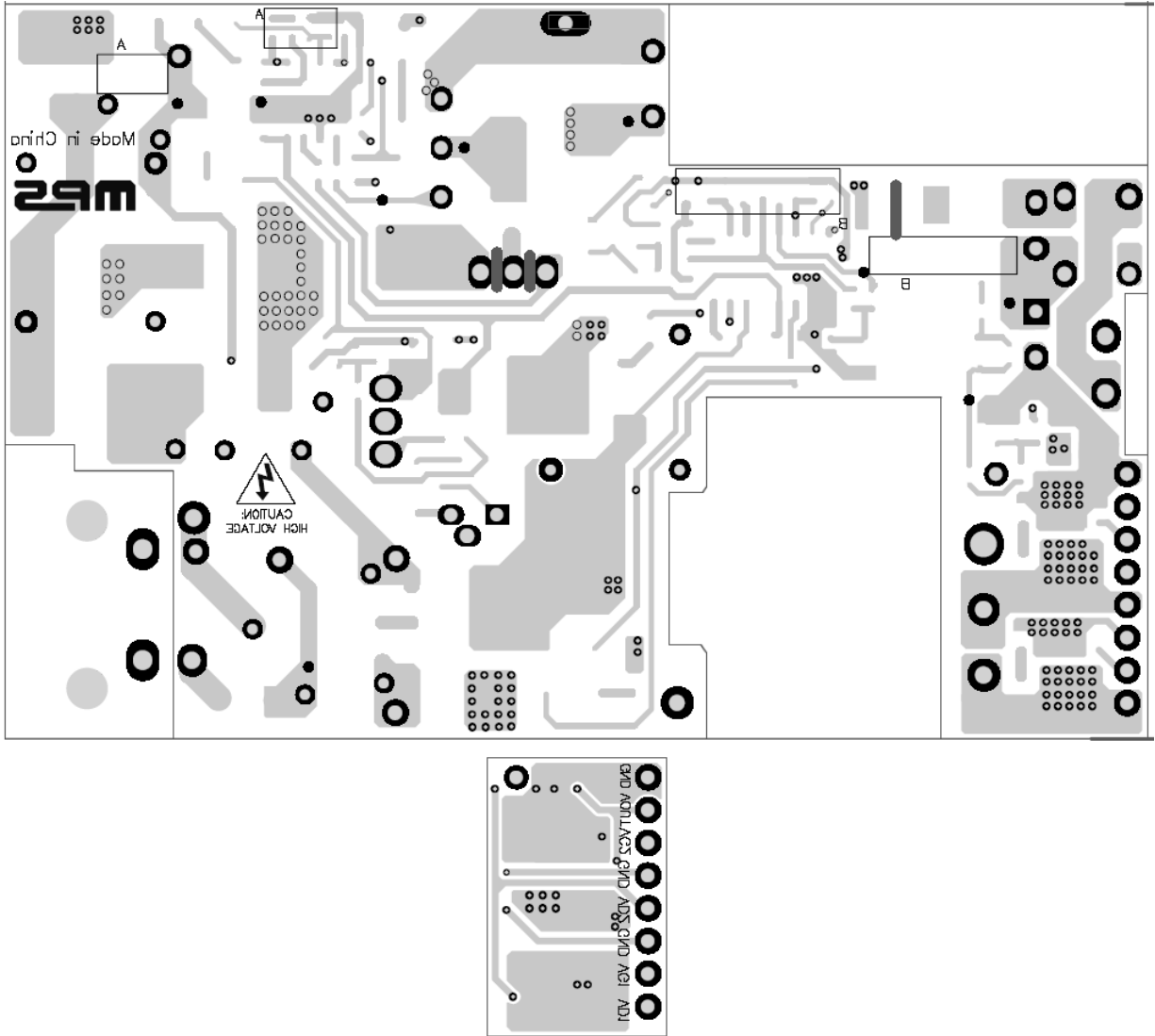

Figure 4—Bottom Layer

QUICK START GUIDE

1. Preset AC input voltage between 90V and 265V. Then turn off AC power supply.
2. Connect the positive and negative terminals of the load to VOUT,GND port,
3. Connect the Line and Neutral terminals of the power supply output to AC input.
4. Turn the power supply on. The board will automatically startup.

APPENDIX: PFC INDUCTOR L4 SPECIFICATION

Electrical Diagram

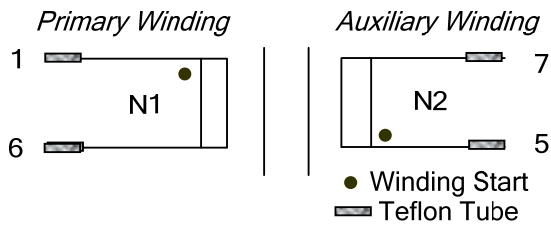

Winding Diagram

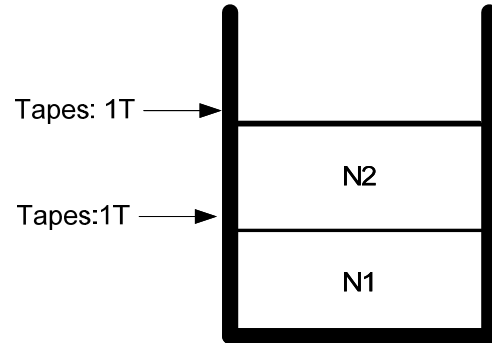

Pin Definition of Bobbin

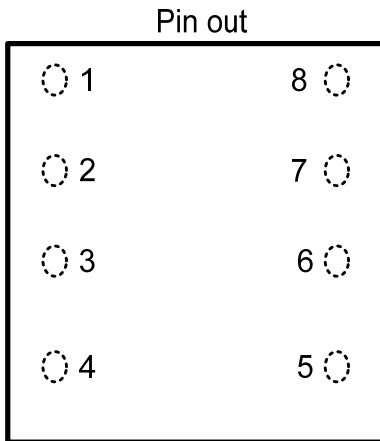

View from the top

Table 1. Electrical Characteristic

Parameter	Condition	Value
Inductance	L4(1-6)	258 μ H \pm 5%
Core		EC26B
Bobbin		EC26B
Core Material		3C85 or equivalent
Turn Ratio	N1:N2	27:9

Table 2. Winding Specification

Tape Turns	Winding No.	Start& End	Wire Diameter (mm)	Turns
1	N1	1→6	0.25×6	27
1	N2	5→7	0.2×1	9
1	Crossed Shielding out of the core			

APPENDIX: LLC RESONANT INDUCTOR L6 SPECIFICATION

Electrical Diagram

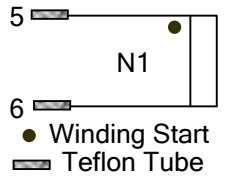

Pin Definition of Bobbin

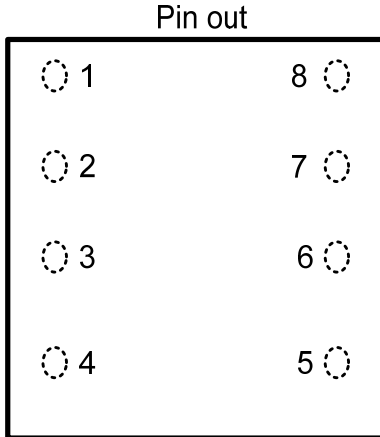

View from the top

Winding Diagram

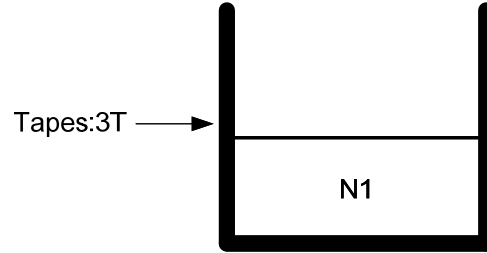

Table 3. Electrical Characteristic

Parameter	Condition	Value
Inductance	L6(5-6)	100 μ H \pm 5%
Core		EPC13
Bobbin		EPC13
Core Material		3C85 or equivalent
Winding Turns	N1	50

Table 4. Winding Specification

Tape Turns	Winding No.	Start& End	Wire Diameter (mm)	Turns
3	N1	5→6	0.25×2	50

APPENDIX: LLC TRANSFORMER T1 SPECIFICATION

Electrical Diagram

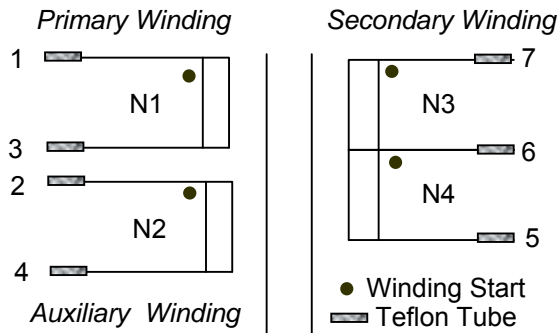

Winding Diagram

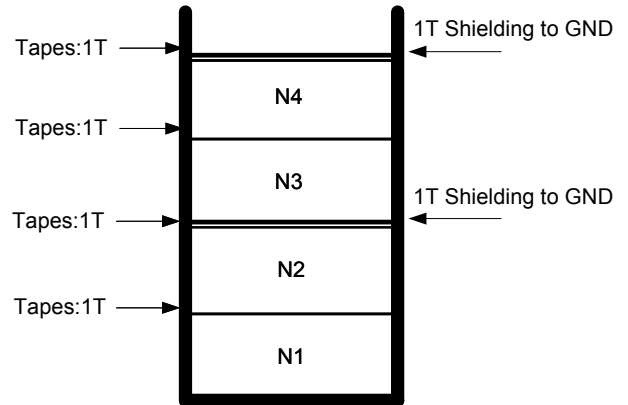

Pin Definition of Bobbin

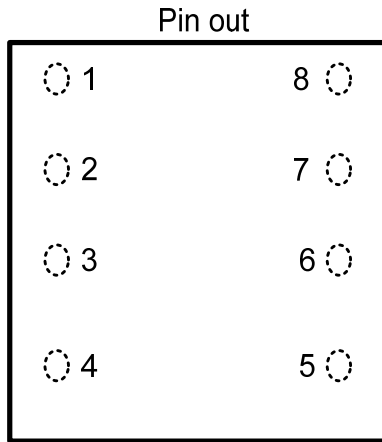

View from the top

Table 5. Electrical Characteristic

Parameter	Condition	Value
Primary Inductance	Lp(1-3)	850μH±5%
Core		EC26B
Bobbin		EC26B
Core Material		3C85 or equivalent
Turn Ratio	N1:N2:N3:N4	31:3:3:3

Table 6. Winding Specification

Tape Turns	Winding No.	Start & End	Wire Diameter (mm)	Turns
1	N1	1→3	0.23×2	31
1	N2	2→4	0.3×1	3
Shielding to GND				
1	N3	7→6	0.23×7 3layers insulated wire	3
1	N4	6→5	0.23×7 3layers insulated wire	3
Shielding to GND				

APPENDIX: COMMON CHOKE L1 SPECIFICATION

Electrical Diagram

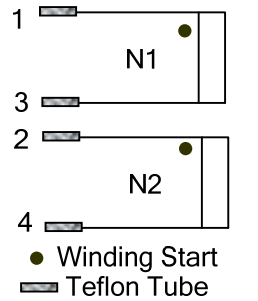

Pin Definition of Bobbin

Pin out



View from the top

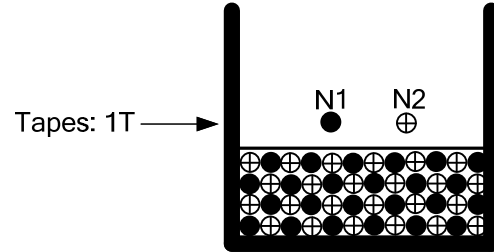

Table 7. Electrical Characteristic

Parameter	Condition	Value
Inductance	L1(1-3 or 2-4)	50 μ H \pm 10%
Core		T10-5-5

Table 8. Winding Specification

Tape Turns	Winding No.	Start& End	Wire Diameter (mm)	Turns
1	N1	1→3	0.4	10
1	N2	2→4	0.4	10
N1,N2 in parallel				

APPENDIX: DIFFERENTIAL CHOKE L3 SPECIFICATION

Electrical Diagram

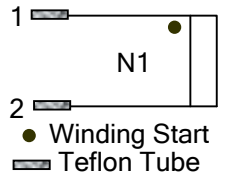

Pin Definition of Bobbin

Pin out



View from the top

Winding Diagram

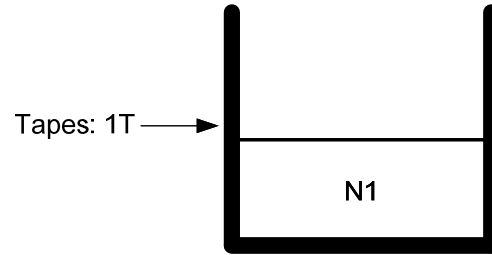

Table 9. Electrical Characteristic

Parameter	Condition	Value
Inductance	L3(1-2)	300 μ H \pm 5%
Core		TMS127125

Table 10. Winding Specification

Tape Turns	Winding No.	Start & End	Wire Diameter (mm)	Turns
1	N1	1 \rightarrow 2	0.25 \times 2	70

APPENDIX: COMMON CHOKE L5 SPECIFICATION

Electrical Diagram

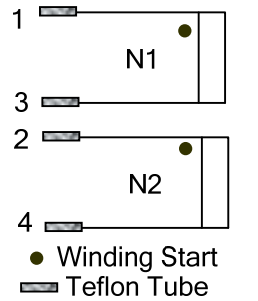

Pin Definition of Bobbin

Pin out



View from the top

Winding Diagram

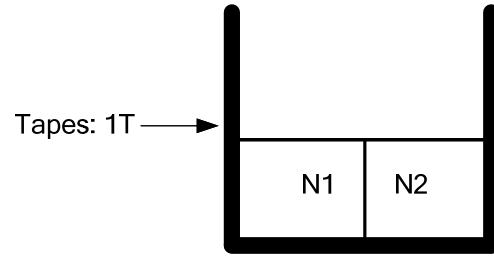

Table 11. Electrical Characteristic

Parameter	Condition	Value
Inductance	L5(1-3 or 2-4)	5.4 μ H \pm 5%
Core		T8-4-4

Table 12. Winding Specification

Tape Turns	Winding No.	Start& End	Wire Diameter (mm)	Turns
1	N1	1→3	0.8	3
1	N2	2→4	0.8	3

NOTICE: The information in this document is subject to change without notice. Users should warrant and guarantee that third party Intellectual Property rights are not infringed upon when integrating MPS products into any application. MPS will not assume any legal responsibility for any said applications.