

## DESCRIPTION

The MP2615A is a high-efficiency, switch mode battery charger suitable for 1- or 2- cell lithium-ion or lithium-polymer applications. The MP2615A is capable of delivering 2 A of charge current programmable via an accurate sense resistor over the entire input range.

The MP2615A regulates the charge current and full battery voltage using two control loops to achieve high-accuracy constant current (CC) charge and constant voltage (CV) charge.

Constant-off-time (COT) control allows operation at up to 99% duty cycle when the battery voltage is close to the input voltage, ensuring the charge current always remains at a relatively high level.

The battery temperature and charging status are always monitored during each charging cycle. Two status monitor output pins are provided to indicate the battery charging status and input power status. Also, the MP2615A features internal reverse-blocking protection.

The MP2615A is available in a 3mm × 3mm 16-pin QFN package.

## FEATURES

- 4.75 V to 18 V Operating Input Voltage
- Up to 99% Duty Cycle Operation
- Up to 2 A Programmable Charging Current
- ±0.75% Full Battery Voltage Accuracy
- 4.2 V/Cell and 4.35 V/Cell Selection for Full Battery Voltage
- Fully Integrated Power Switches
- Internal Loop Compensation
- No External Reverse-Blocking Diode Required
- Preconditioning for Fully Depleted Battery
- Charging Operation Indicator
- Programmable Safety Timer
- Thermal Shutdown Protection
- Cycle-by-Cycle Over-Current Protection
- Battery Temperature Monitor and Protection

## APPLICATIONS

- Smart Phones
- Portable Hand-Held Solutions
- Portable Media Players

All MPS parts are lead-free, halogen-free, and adhere to the RoHS directive. For MPS green status, please visit the MPS website under Quality Assurance.

"MPS" and "The Future of Analog IC Technology" are registered trademarks of Monolithic Power Systems, Inc.

Analog digital adaptive modulation (ADAM) and advanced asynchronous modulation (AAM) are trademarks of Monolithic Power Systems, Inc.

## TYPICAL APPLICATION

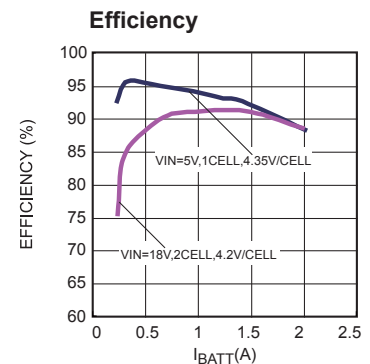
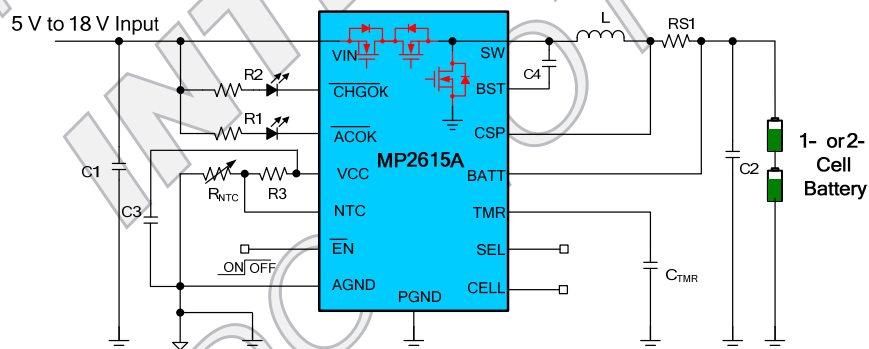

### ORDERING INFORMATION

Part Number*	Package	Top Marking
MP2615AGQ	QFN-16 (3mm × 3mm)	See Below

\* For Tape & Reel, add suffix –Z (e.g. MP2615AGQ–Z).

### TOP MARKING

**ANKY**  
**LLL**

ANK: Product code of MP2615A  
Y: Year code  
LLL: Lot number

### PACKAGE REFERENCE

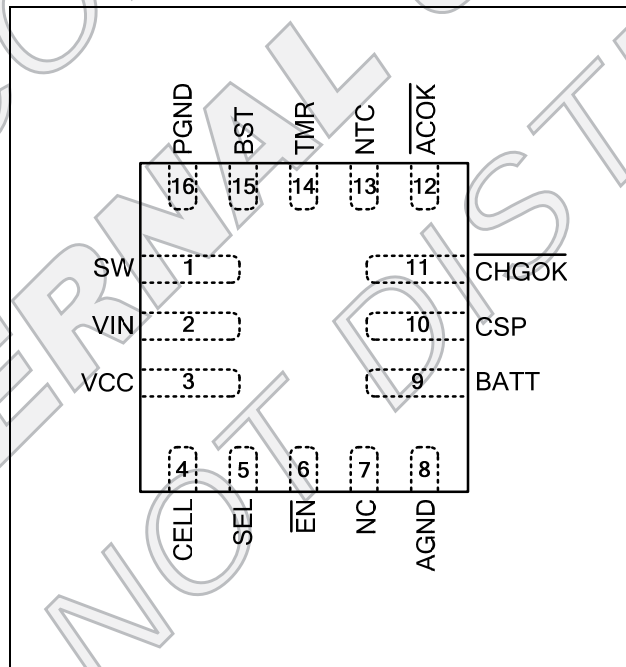

**ABSOLUTE MAXIMUM RATINGS <sup>(1)</sup>**

$V_{SW}$ .....	-0.3 V to 23 V
$V_{IN}, V_{ACOK}, V_{CHGOK}$ .....	-0.3 V to 23 V
$V_{BATT}, V_{CSP}$ .....	-0.3 V to 12 V
$V_{BST}$ .....	$V_{SW} + 6$ V
All other pins.....	-0.3 V to 6 V
Junction temperature.....	150°C
Lead temperature.....	260°C
Continuous power dissipation ( $T_A = +25^\circ\text{C}$ ) <sup>(2)</sup>	
.....	2.5 W
Operating temperature.....	-40°C to +85°C

**Recommended Operating Conditions <sup>(3)</sup>**

$V_{IN}$ .....	4.75 V to 18 V
$V_{BATT}$ .....	2 V to 8.7 V
Operating junction temp. ( $T_J$ )..	-40°C to +125°C

<b>Thermal Resistance <sup>(4)</sup></b>	<b><math>\theta_{JA}</math></b>	<b><math>\theta_{JC}</math></b>	
QFN-16 (3mm x 3mm).....	50	12...	°C/W

**NOTES:**

- 1) Exceeding these ratings may damage the device.
- 2) The maximum allowable power dissipation is a function of the maximum junction temperature  $T_J$  (MAX), the junction-to-ambient thermal resistance  $\theta_{JA}$ , and the ambient temperature  $T_A$ . The maximum allowable continuous power dissipation at any ambient temperature is calculated by  $P_D$  (MAX) =  $(T_J$  (MAX)- $T_A$ )/ $\theta_{JA}$ . Exceeding the maximum allowable power dissipation produces an excessive die temperature, causing the regulator to go into thermal shutdown. Internal thermal shutdown circuitry protects the device from permanent damage.
- 3) The device is not guaranteed to function outside of its operating conditions.
- 4) Measured on JESD51-7, 4-layer PCB.

MPS CONFIDENTIAL  
INTERNAL USE ONLY  
DO NOT DISTRIBUTE

**ELECTRICAL CHARACTERISTICS**
 $V_{IN} = 12\text{ V}$ ,  $V_{CELL} = 0\text{ V}$ ,  $V_{SEL} = 0\text{ V}$ ,  $C1 = 22\text{ }\mu\text{F}$ ,  $C2 = 22\text{ }\mu\text{F}$ ,  $T_A = 25^\circ\text{C}$ , unless otherwise noted.

Parameter	Symbol	Condition	Min	Typ	Max	Units
<b>Input voltage and current</b>						
Input voltage	$V_{IN}$	$V_{CELL} = 4\text{ V}$	4.5	5	18	V
		$V_{CELL} = 0\text{ V}$	8.75	12	18	
Under-voltage lockout threshold rising	$V_{UVLO}$		3.55	3.75	3.95	V
Under-voltage lockout threshold hysteresis				225		mV
Supply current	$I_{SHDN}$	$\overline{EN} = 4\text{ V}$ , Shutdown current		0.27		mA
	$I_Q$	$\overline{EN} = 0\text{ V}$ , Quiescent current		1.1		
<b>Power MOS</b>						
High-side switch on resistance	$R_{H\_DS(ON)}$	Measured from VIN to SW		110		m $\Omega$
Low-side switch on resistance	$R_{L\_DS(ON)}$			110		m $\Omega$
Switch leakage		$\overline{EN} = 4\text{ V}$ , $V_{SW} = 0\text{ V}$		0	1	$\mu\text{A}$
<b>Frequency and time parameter</b>						
Switching frequency	$F_{SW}$	$V_{BATT} = 7.5\text{ V}$		760		kHz
Foldback frequency		$V_{BATT} = 0\text{ V}$		160		kHz
Minimum off time <sup>(5)</sup>	$T_{OFF}$	$V_{BATT} = 9\text{ V}$		200		ns
<b>Charging parameter</b>						
Terminal battery voltage	$V_{BATT\_FULL}$	$V_{SEL} = 0\text{ V}$	4.328	4.35	4.386	V/Cell
		$V_{SEL} = 4\text{ V}$	4.168	4.2	4.252	
Battery over-voltage threshold	$V_{BOVP}$	$V_{SEL} = 0\text{ V}$ $V_{CELL} = 0\text{ V}$	8.62	8.99	9.36	V
		$V_{SEL} = 4\text{ V}$ $V_{CELL} = 0\text{ V}$	8.34	8.71	9.08	
		$V_{SEL} = 0\text{ V}$ $V_{CELL} = 4\text{ V}$	4.3	4.49	4.67	
		$V_{SEL} = 4\text{ V}$ $V_{CELL} = 4\text{ V}$	4.17	4.36	4.54	
Recharge threshold at $V_{BATT}$	$V_{RECH}$	$V_{SEL} = 0\text{ V}$		4.1		V/Cell
		$V_{SEL} = 4\text{ V}$		4.0		
Recharge hysteresis				150		mV/Cell
Trickle charge voltage threshold	$V_{TC}$	$V_{SEL} = 0\text{ V}$		3.1		V/Cell
		$V_{SEL} = 4\text{ V}$		3.0		
Trickle charge hysteresis				225		mV/Cell
Peak current limit		CC	3.2			A
		Trickle		2.2		
CC current	$I_{CC}$	$RS1 = 50\text{ m}\Omega$	1.8	2	2.2	A
Trickle charge current	$I_{TC}$		5%	10%	15%	$I_{CC}$

**ELECTRICAL CHARACTERISTICS (continued)**
 $V_{IN} = 12\text{ V}$ ,  $V_{CELL} = 0\text{ V}$ ,  $V_{SEL} = 0\text{ V}$ ,  $C1 = 22\ \mu\text{F}$ ,  $C2 = 22\ \mu\text{F}$ ,  $T_A = 25^\circ\text{C}$ , unless otherwise noted.

Parameter	Symbol	Condition	Min	Typ	Max	Units
Termination current threshold	$I_{BF}$		5%	10%	15%	$I_{CC}$
$V_{IN}$ minimum head-room (reverse blocking)		$V_{IN} - V_{BATT}$		300		mV
Maximum current-sense voltage (CSP to BATT)	$V_{SENSE}$		90	100	110	mV
CSP, BATT current	$I_{CSP}$ , $I_{BATT}$	Charging disabled			3	$\mu\text{A}$
ACOK/CHGOK open-drain sink current		$V_{DRAIN} = 0.3\text{ V}$	5			mA
<b>VCC regulator output</b>						
VCC output voltage	$V_{CC}$		4.25	4.5	4.75	V
VCC load regulation	$\Delta V_{CC}$	$I_{LOAD} = 0$ to 10 mA			10	mV
<b>EN control</b>						
$\overline{EN}$ input low voltage					0.4	V
$\overline{EN}$ input high voltage			1.8			V
$\overline{EN}$ input current	$I_{EN}$	$\overline{EN} = 4\text{ V}$		4		$\mu\text{A}$
		$\overline{EN} = 0\text{ V}$		0.2		
<b>Timer protection</b>						
Trickle charge time	$t_{Trickle\_tmr}$	$C_{TMR} = 0.47\ \mu\text{F}$		30		Mins
CC/CV charge time	$t_{Total\_tmr}$	$C_{TMR} = 0.47\ \mu\text{F}$		165		
<b>NTC protection</b>						
NTC low temp rising threshold		$R_{NTC} = \text{NCP18 x 103, } 0^\circ\text{C}$	72	73.3	74.6	% $V_{CC}$
NTC low temp rising threshold hysteresis				2		
NTC high temp falling threshold		$R_{NTC} = \text{NCP18 x 103, } 50^\circ\text{C}$	28	29.3	30.6	
NTC low temp falling threshold hysteresis				2		
<b>Thermal protection</b>						
Thermal shutdown <sup>(5)</sup>	$T_{SHDN}$			150		$^\circ\text{C}$
Thermal shutdown hysteresis <sup>(5)</sup>				20		$^\circ\text{C}$
<b>Reverse leakage blocking</b>						
Battery reverse leakage current	$I_{LEAKAGE}$	$V_{CELL} = 0\text{ V}$			3	$\mu\text{A}$
		$V_{CELL} = 4\text{ V}$			0.5	$\mu\text{A}$

**NOTES:**

5) Guaranteed by design.

## PIN FUNCTIONS

Package Pin #	Name	Description
1	SW	Switch output.
2	VIN	Power supply voltage.
3	VCC	<b>Coarse regulator output.</b> Internally generated 4.5 V. Bypass with a 1 $\mu$ F capacitor to AGND. Used as low-side switch driver and pull-up bias voltage NTC resistive divider. <b>Do NOT connect an external load to VCC.</b>
4	CELL	<b>Command input for the number of li-ion cells.</b> Connect CELL to VCC for 1-cell application; short CELL to AGND for 2-cell application.
5	SEL	<b>Input pin for setting terminal battery voltage:</b> SEL = Low-level: $V_{BATT} = 4.35$ V/cell. SEL = High-level: $V_{BATT} = 4.2$ V/cell.
6	$\overline{EN}$	<b>On/off control input.</b> $\overline{EN}$ is pulled to GND with a 1 M internal resistor.
7	NC	<b>No connection.</b> Please leave NC floating.
8	AGND	<b>Analog ground.</b>
9	BATT	<b>Positive battery terminal.</b>
10	CSP	<b>Battery current sense positive input.</b> Connect a resistor (RS1) between CSP and BATT.
11	$\overline{CHGOK}$	<b>Charging complete indicator.</b> A logic low indicates a charging operation. $\overline{CHGOK}$ will become an open drain once the charge is completed or suspended.
12	$\overline{ACOK}$	<b>Valid input supply indicator.</b> A logic low on $\overline{ACOK}$ indicates the presence of a valid input power supply.
13	NTC	<b>Thermistor input.</b> Connect a resistor from NTC to VCC and the thermistor from NTC to ground.
14	TMR	<b>Internal safety timer control.</b> Connect a capacitor from this node to AGND to set the timer. The timer can be disabled by connecting TMR to AGND directly.
15	BST	<b>Bootstrap.</b> A capacitor is needed to drive the power switch's gate above the supply voltage. It is connected between SW and BST to form a floating supply across the power switch driver.
16	PGND	<b>Power ground.</b>

### TYPICAL PERFORMANCE CHARACTERISTICS

$V_{IN} = 5 \text{ V/9 V}$ ,  $C1 = C2 = 22 \mu\text{F}$ ,  $\text{SEL} = \text{Low/High}$ ,  $\text{CELL} = \text{Low/High}$ ,  $L = 6.8 \mu\text{H}$ ,  $R_{S1} = 50 \text{ m}\Omega$ , battery simulator,  $T_A = 25^\circ\text{C}$ , unless otherwise noted.

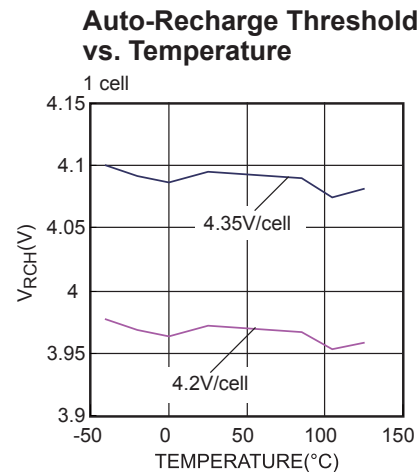
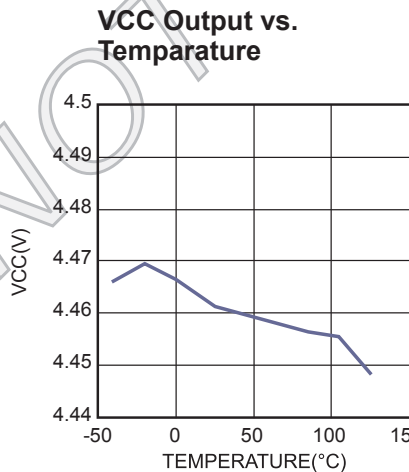
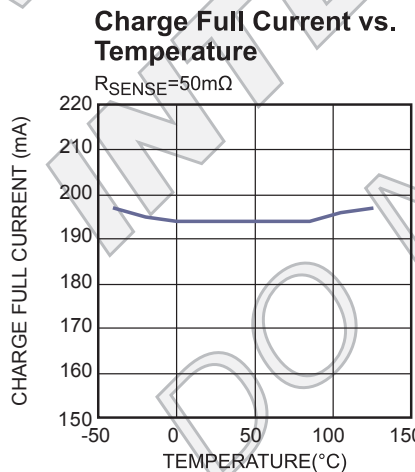
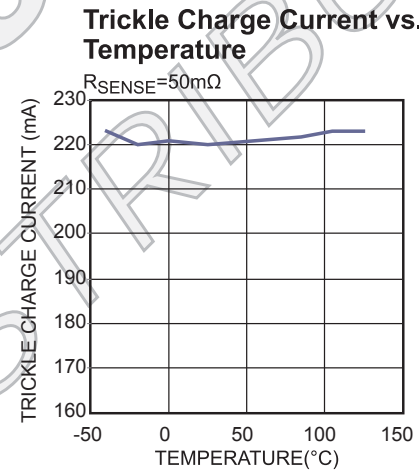
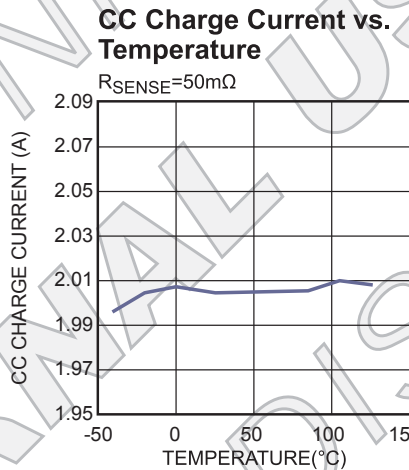
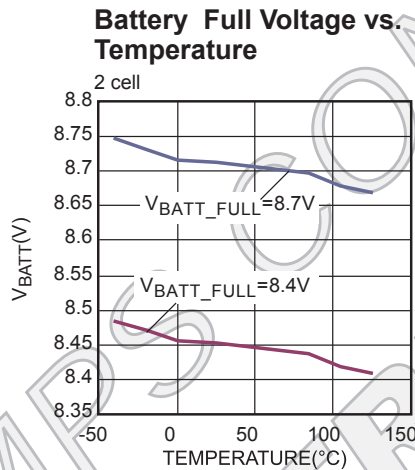
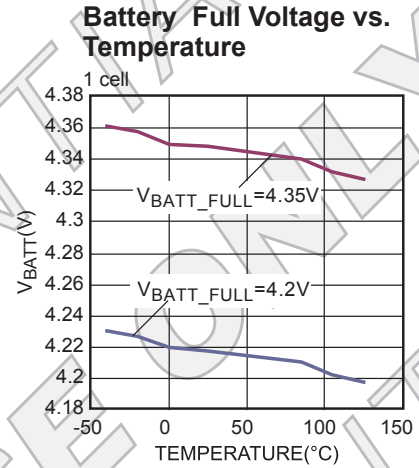
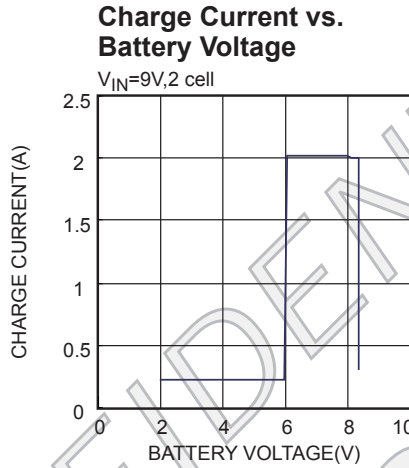
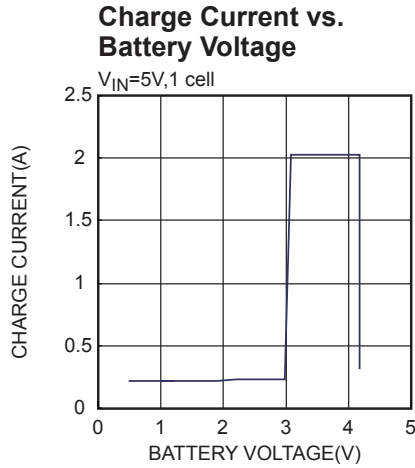

**TYPICAL PERFORMANCE CHARACTERISTICS (continued)**

$V_{IN} = 5\text{ V}/9\text{ V}$ ,  $C1 = C2 = 22\ \mu\text{F}$ ,  $SEL = \text{Low/High}$ ,  $CELL = \text{Low/High}$ ,  $L = 6.8\ \mu\text{H}$ ,  $RS1 = 50\ \text{m}\Omega$ , battery simulator,  $T_A = 25^\circ\text{C}$ , unless otherwise noted.

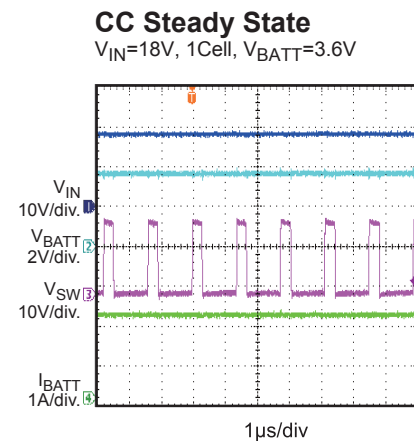
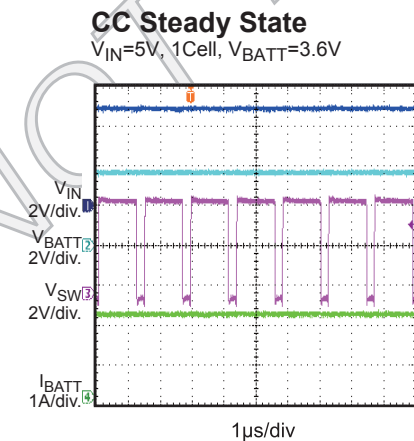
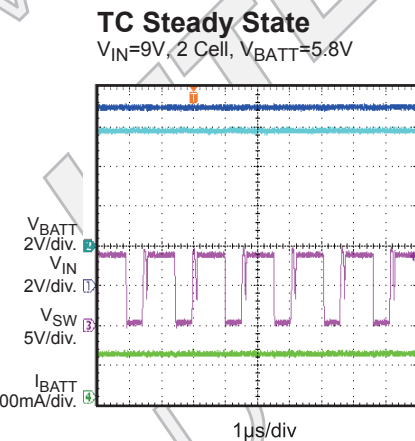
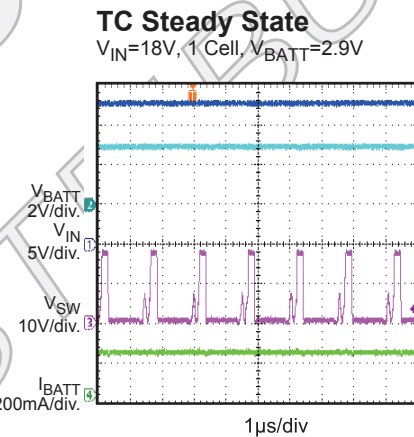
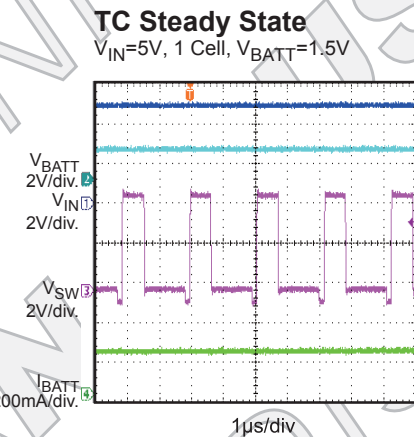
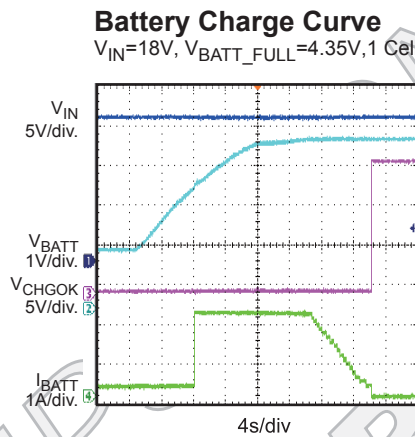
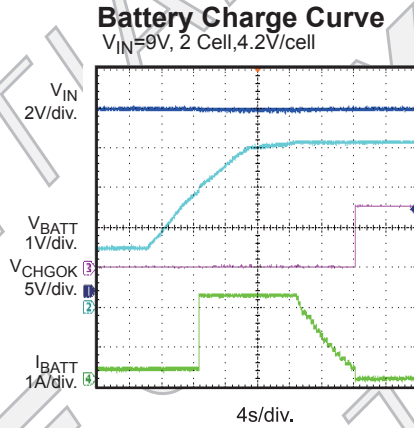
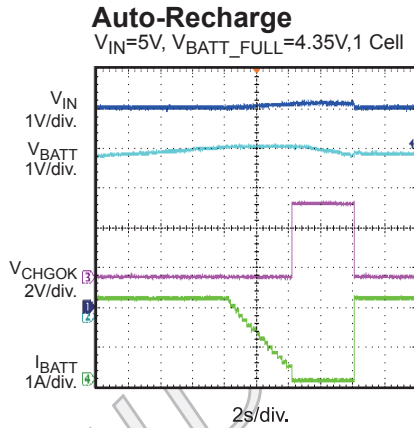
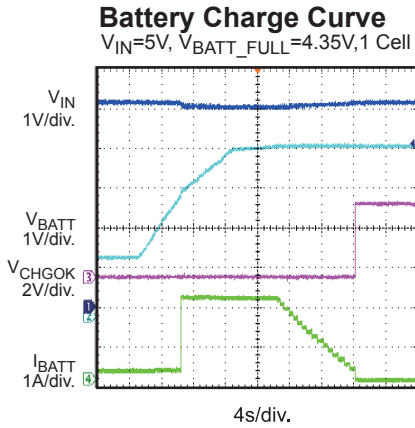



**TYPICAL PERFORMANCE CHARACTERISTICS (continued)**

$V_{IN} = 5 \text{ V/9 V}$ ,  $C1 = C2 = 22 \mu\text{F}$ , SEL = Low/High, CELL = Low/High,  $L = 6.8 \mu\text{H}$ ,  $RS1 = 50 \text{ m}\Omega$ , battery simulator,  $T_A = 25^\circ\text{C}$ , unless otherwise noted.

**CC Steady State**

$V_{IN}=18\text{V}$ , 2Cell,  $V_{BATT}=8.0\text{V}$

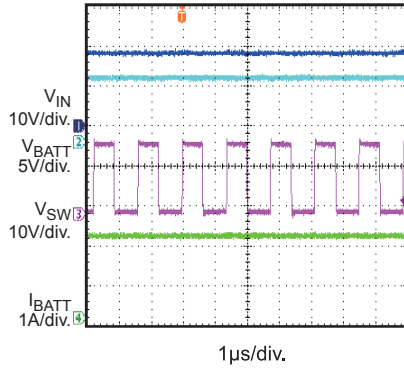

**CC Steady State**

$V_{IN}=12\text{V}$ , 2Cell,  $V_{BATT}=6\text{V}$

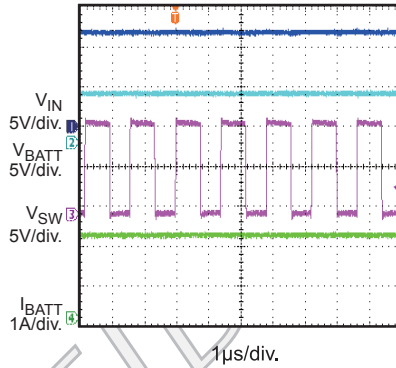

**CC Steady State (COT)**

$V_{IN}=4.75\text{V}$ , 1Cell, 4.35V/cell,  $V_{BATT}=4.1\text{V}$

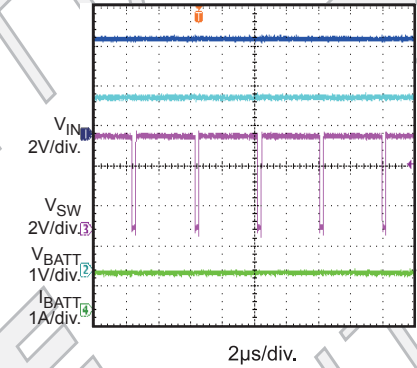

**CC Steady State (BST Refresh)**

$V_{IN}=9.0\text{V}$ , 2Cell, 4.35V/cell,  $V_{BATT}=8.67\text{V}$

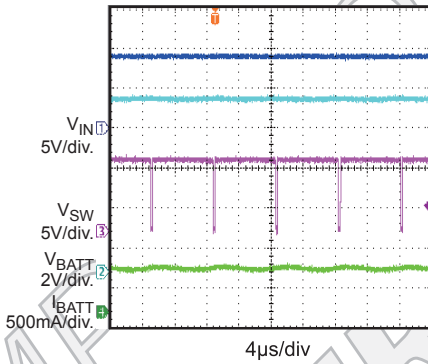

**CV Steady State**

$V_{IN}=5\text{V}$ , 1Cell,  $V_{BATT}=4.35\text{V}$

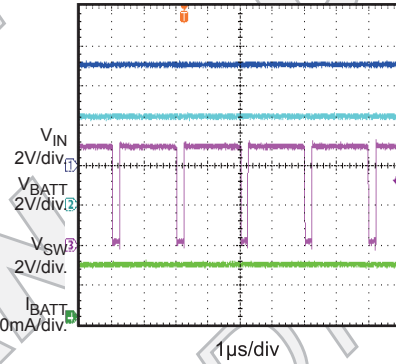

**CV Steady State**

$V_{IN}=18\text{V}$ , 1Cell,  $V_{BATT}=4.2\text{V}$

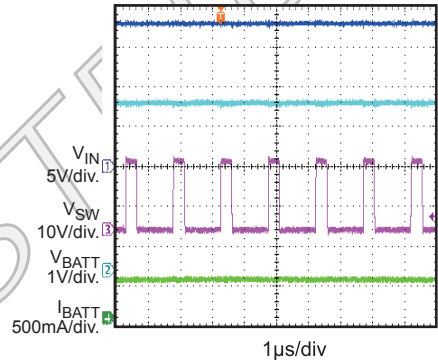

**CV Steady State (COT)**

$V_{IN}=9\text{V}$ , 2Cell,  $V_{BATT}=8.4\text{V}$

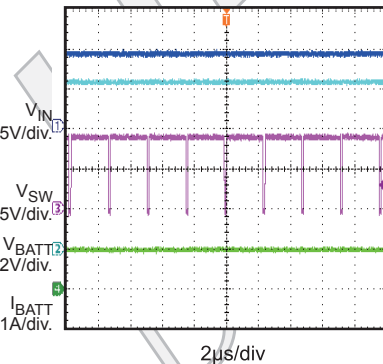

**Power On**

$V_{IN}=9\text{V}$ , 1Cell,  $V_{BATT}=3.6\text{V}$

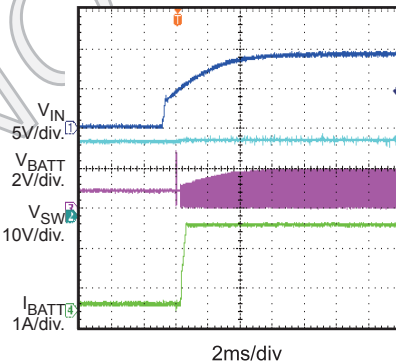

**Power Off**

$V_{IN}=5\text{V}$ , 1Cell,  $V_{BATT}=3.6\text{V}$

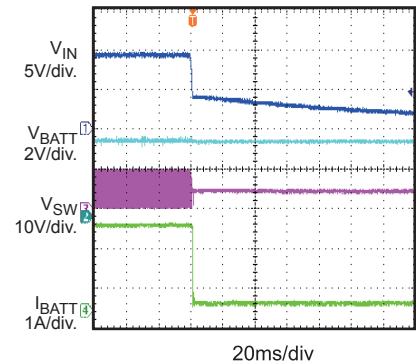

**TYPICAL PERFORMANCE CHARACTERISTICS (continued)**

$V_{IN} = 5\text{ V}/9\text{ V}$ ,  $C1 = C2 = 22\ \mu\text{F}$ , SEL = Low/High, CELL = Low/High,  $L = 6.8\ \mu\text{H}$ ,  $RS1 = 50\ \text{m}\Omega$ , battery simulator,  $T_A = 25^\circ\text{C}$ , unless otherwise noted.

**Hot Insertion**

$V_{IN} = 9\text{V}$ , 1 Cell,  $V_{BATT} = 4.35\text{V}$

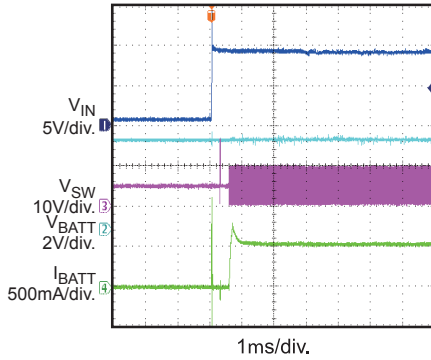

**Hot Insertion**

$V_{IN} = 12\text{V}$ , 2 Cell,  $V_{BATT} = 7.2\text{V}$

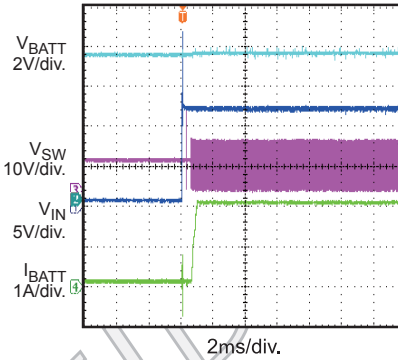

**Power On**

$V_{IN} = 12\text{V}$ , 1 Cell,  $V_{BATT} = 4.2\text{V}$

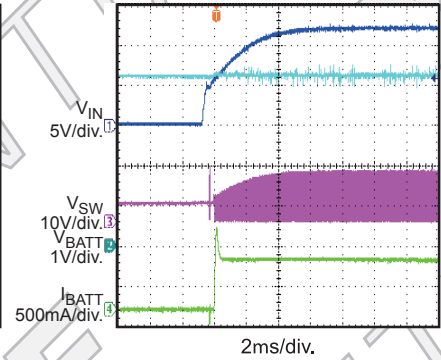

**EN On**

$V_{IN} = 5\text{V}$ , 1 Cell,  $V_{BATT} = 4.35\text{V}$

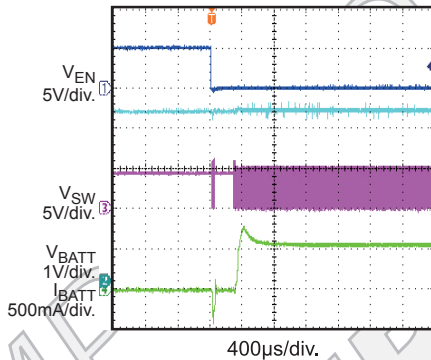

**EN On**

$V_{IN} = 12\text{V}$ , 2 Cell,  $V_{BATT} = 7.2\text{V}$

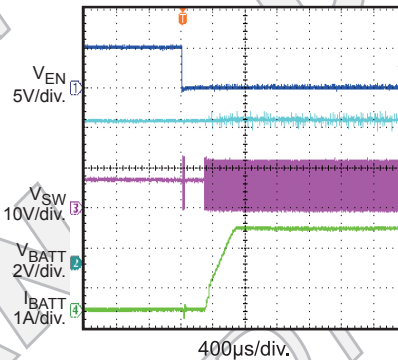

**EN Off**

$V_{IN} = 18\text{V}$ , 2 Cell,  $V_{BATT} = 8.4\text{V}$

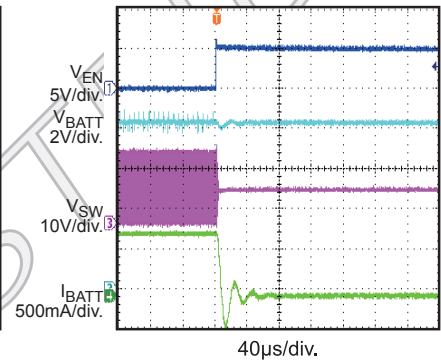

**NTC Fault Control**

$V_{IN} = 5\text{V}$ , 1 Cell,  $V_{BATT} = 3.6\text{V}$

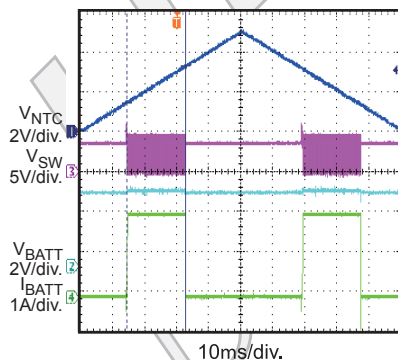

**Timer Out**

$V_{IN} = 9\text{V}$ , 2 Cell,  $V_{BATT} = 8.4\text{V}$ ,  $C_{TMR} = 470\text{pF}$

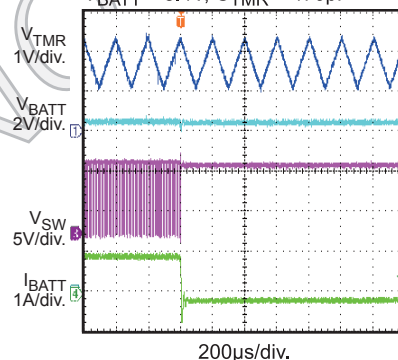

**Charge Full Indication**

$V_{IN} = 12\text{V}$ , 2 Cell,  $V_{BATT} = 8.4\text{V}$

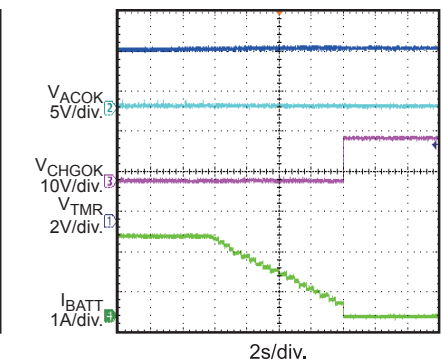

FUNCTIONAL BLOCK DIAGRAM

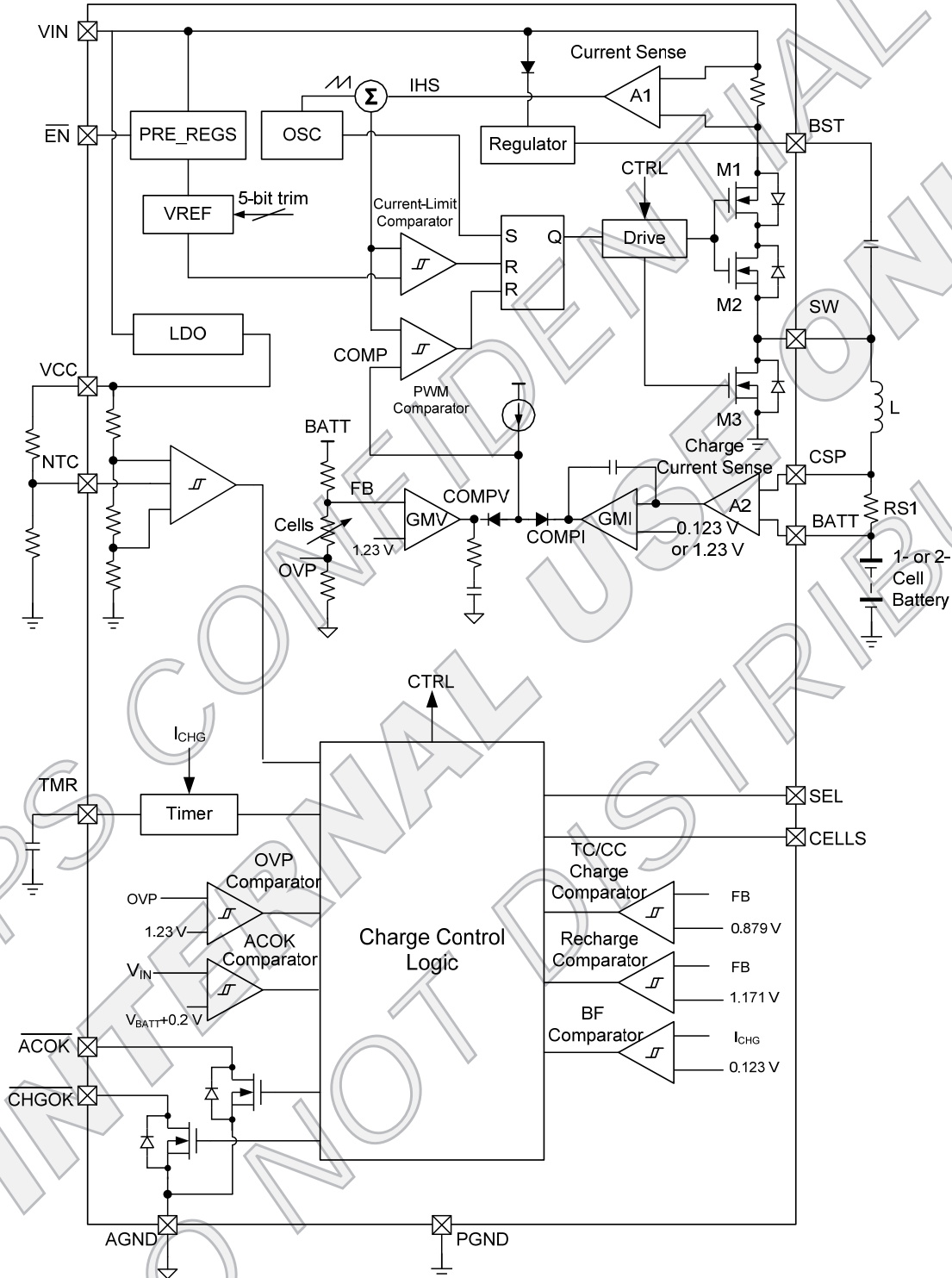

Figure 1—Functional block diagram

**OPERATION**

The MP2615A is a peak current mode controlled switching charger for 1- or 2- cell lithium-ion and lithium-polymer batteries. The MP2615A integrates both the high-side and low-side switches of the synchronous buck converter to provide high efficiency and save space on the PCB.

**Charge Cycle (Mode Change: TC → CC → CV)**

The MP2615A regulates the charge current ( $I_{CHG}$ ) and battery voltage ( $V_{BATT}$ ) using two control loops. This achieves highly-accurate constant current (CC) charge and constant voltage (CV) charge.

As shown in Figure 2, when the  $V_{BATT} < V_{TC}$ , the MP2615A stays in trickle-charge mode, and the output of the charge current loop (COMPI) dominates the control. The battery is charged by

a trickle-charge current ( $I_{TC}$ ) until the battery voltage reaches  $V_{TC}$ . If the charger stays in the trickle-charge mode until the trickle-charge timer is triggered, charging will be terminated.

The MP2615A enters constant-current charge mode once the battery voltage rises higher than  $V_{TC}$ . In this mode, the charge current increases from  $I_{TC}$  to  $I_{CC}$  to fast charge the battery.

When the battery voltage rises over the full battery voltage ( $V_{BATT\_FULL}$ ), the charger enters constant-voltage mode. In constant-voltage mode, the battery voltage is regulated at  $V_{BATT\_FULL}$  precisely, and the charge current decreases naturally due to the existing equivalent internal resistance of the battery. For the operation flow chart, please refer to Figure 4.

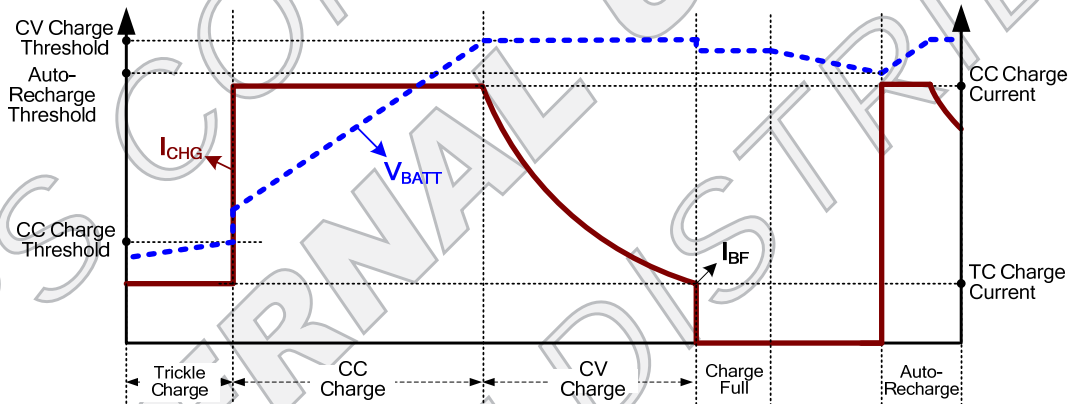

Figure 2—Li-ion battery charge profile

### Charge Full Termination and Auto-Recharge

When the charge current drops below the termination threshold ( $I_{BF}$ ) during the CV charge phase, the charger stops charging and  $\overline{CHGOK}$  becomes an open drain. Also, the timer is re-set and turns off. Once the battery voltage decreases below the recharge threshold ( $V_{RECH}$ ), recharging kicks in automatically, and the timer re-starts a new charge cycle.

### COT Charge Mode

The MP2615A uses the floating ground method to drive the high-side MOSFET (HS-FET) of the buck converter. During the HS-FET off time, the BST capacitor is recharged, and the voltage across the BST capacitor is used as the HS-FET gate drive. Thus a minimum off-time (200ns) is required to maintain sufficient voltage at the BST capacitor.

When the 200ns minimum off-time is achieved, due to a large duty cycle, the MP2615A enters constant off-time (COT) charge mode. In this mode of operation, the switching frequency is decreased slightly in order to achieve a 99% duty cycle.

### Charge Status Indication

The MP2615A has two open-drain status outputs:  $\overline{CHGOK}$  and  $\overline{ACOK}$ .  $\overline{ACOK}$  goes low when the input voltage is 300 mV larger than the battery voltage, and it rises above the under-voltage lockout threshold.  $\overline{CHGOK}$  indicates the status of the charge cycle. Table 1 summarizes the operation of both  $\overline{CHGOK}$  and  $\overline{ACOK}$  according to the charging status.

**Table 1—Charging status indication**

$\overline{ACOK}$	$\overline{CHGOK}$	Charger Status
Low	Low	In charging
Low	High impedance	End of charge NTC fault Timer out $\overline{EN}$ disable Thermal shutdown
High impedance	High impedance	$V_{IN}$ absent $V_{IN} - V_{BATT} < 0.3 V$

### Safety Timer Operation

The MP2615A has an internal safety timer to terminate charging during time out. The capacitor ( $C_{TMR}$ ) connected between TMR and GND is used to set the internal oscillator period. See Equation (1):

$$T_p(\text{seconds}) = 0.46 \times C_{TMR}(\mu\text{F}) \quad (1)$$

This timer limits the maximum trickle charge time to 8192 internal oscillating periods. If the charger stays in trickle-charge mode for longer than the maximum oscillating periods, it is terminated.

$\overline{CHGOK}$  becomes an open drain to indicate the timer-out fault. If the charge cycle goes through the trickle charge successfully within the allowed time limit, it enters CC charge mode, and the timer continues to count the oscillating periods. When the battery is fully charged, the timer turns off and clears the counter, waiting for the auto-recharge to re-start.

If the charge time during the CC/CV modes exceed 49152 oscillating periods, and the *battery full* has not been qualified, the charger is terminated, and a timer-out fault is indicated by floating  $\overline{CHGOK}$ . The charger exits the timer-out fault state, and the on-chip safety timer re-starts counting when the following conditions occur:

- The battery voltage falls below the auto-recharge threshold ( $V_{RECH}$ );
- a power-on-reset (POR) event occurs;
- $\overline{EN}$  is toggled.

The timer can be disabled by pulling TMR to AGND.

Thus, the trickle mode charge time is calculated using Equation (2):

$$t_{\text{Trickle\_tmr}}(\text{minutes}) = 62.8 \times C_{TMR}(\mu\text{F}) \quad (2)$$

If a  $C_{TMR}$  (0.47 $\mu\text{F}$ ) is connected, the trickle charge time is about 30 minutes.

The CC/CV mode charge time is calculated with Equation (3):

$$t_{\text{Total\_tmr}}(\text{hours}) = 6.28 \times C_{TMR}(\mu\text{F}) \quad (3)$$

If a  $C_{TMR}$  (0.47  $\mu\text{F}$ ) is connected, the CC/CV charge time is 2.95 hours.

### Negative Thermal Coefficient (NTC) Thermistor

NTC allows the MP2615A to sense the battery temperature using an negative thermal coefficient (NTC) resistor. This resistor is available in the battery pack to ensure a safe operating environment for the battery. A resistor with an appropriate value should be connected from VCC to NTC, and the thermistor should be connected from NTC to AGND. The voltage on NTC is determined by the resistor divider whose divide-ratio depends on the battery temperature. When the voltage at NTC falls out of the NTC window range, the charging will pause until the battery temperature goes back to normal operating conditions.

As a result, the MP2615A stops charging and reports this condition to the status pins. Charging resumes automatically after the temperature falls back within safe range.

### Short-Circuit Protection

The MP2615A has an internal comparator to check for a battery short circuit. Once  $V_{BATT}$  falls below 2 V, the device detects a battery-short status, and the cycle-by-cycle peak current limit falls to about 2.2 A to limit the current spike during the battery-short transition. Also, the switching frequency folds back to minimize the power loss.

### Thermal Shutdown Protection (TSD)

To prevent the chip from overheating during charging, the MP2615A monitors the junction temperature ( $T_J$ ), of the die. Once  $T_J$  reaches the thermal shutdown threshold ( $T_{SHUTDOWN}$ ) of 150°C, the charger converter turns off. Once  $T_J$  falls below 130°C the charging re-starts.















